

success

QPS<sup>®</sup>

SES<sup>®</sup>

# Electrical Apparatus

*SUPER-LITE™*

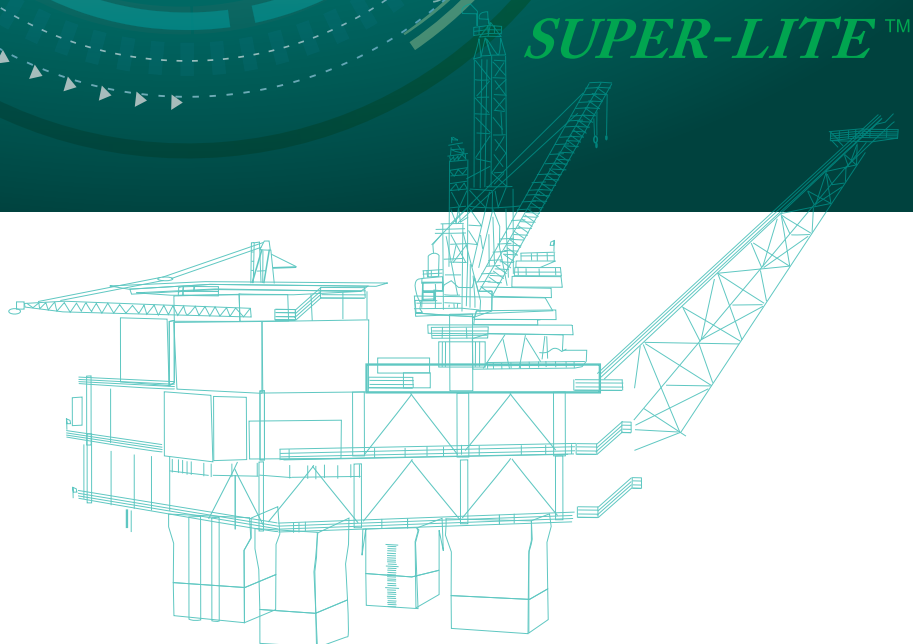

## Responding to a Changing World

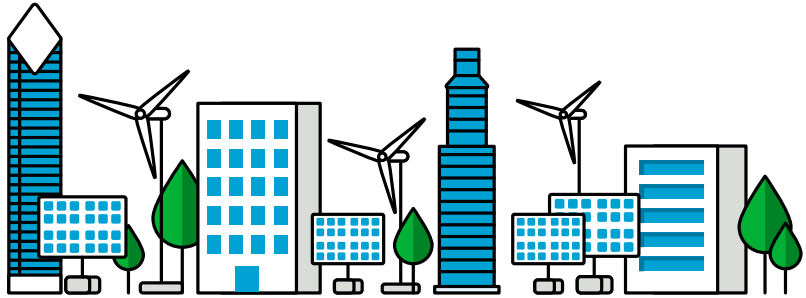

*“In the past several years, there has been an accelerated rate of change to introduce energy efficiency standards globally not only for lighting but for transformers as well.”*

**Success** designs and manufactures **Low Voltage Dry-Type Transformers** using the Vacuum Pressure Impregnation (VPI) technology which already proven to be highly reliable over the years used in diverse commercial and industrial environments. These transformers are used in many applications including in commercial buildings, on board of vessels as well as in deep mines and industrial environment as well as the most demanding and special requirements including **OPTIMIZED SPACE UTILIZATION**.

## Safe, Reliable & Energy Efficient

To minimize fire hazard and environmental contamination, dry-type transformers are requested more and more frequently whenever the risk of fire is a prime concern. **QPS**<sup>®</sup> transformers meet strict parameters with respect to electrical system demands, losses, and functioning in areas with extreme climatic conditions. **QPS**<sup>®</sup> dry-type transformers are virtually maintenance free and suitable to be installed in places with high people density such as airports, stadiums, hospitals, shopping centers, skyscrapers, factories, power and industrial plants.

*“Quality and innovation are two of the company’s central philosophies. To this end, we use up-to-date technology and we are constantly researching to develop new systems and products.”*



Success is a transformer and lighting manufacturing company incorporated in Malaysia since 1980 wholly-owned by Success Transformer Corporation Berhad (STC), a public listed company in the Main Board of Bursa Malaysia. We have been the foremost provider of lighting and power distribution technologies, enabling new and more efficient uses of energy in industrial areas that can transform our world both visually and practically.

*“With our capabilities, we are able to manufacture from ground up, to match as close to perfection as possible to your compliance, performance and output, sustainability & consumption specifications.”*

Our Complete Solutions Workflow begin from conception all the way to final installation on site. We have amassed the necessary software, and hardware and expertise. Success is an Original Design Manufacturer (ODM) where we design and manufacture products for customers under their own brands, and an Original Equipment Manufacturer (OEM) where we manufacture products for customers according to their designs. We can create any design, in almost any situation, and we will present a visual rendering of the design or design area to the customer as part of our pre-sales service to visualize your ideas.

We are using the most advanced production technologies and the most demanding control systems to guarantee the highest quality and total product reliability. Considerable investments have been made to upgrade equipment, quality certification and laboratory testing facilities, in particular for our low voltage transformer and LED lighting sectors.

Every product from Success is manufactured in accordance with industry and international standards including ISO 9001. Our ability to meet the customer’s requirements is constantly being evaluated and improved to deliver more efficiency, effectiveness and flexibility to assure their benefit.

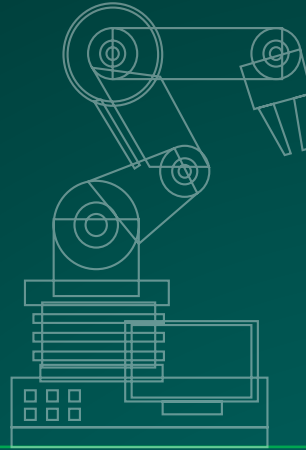

## CONTENTS

- 01 POWER TRANSFORMER
- 03 MOTOR STARTING AUTO TRANSFORMER
- 05 VARIABLE VOLTAGE TRANSFORMER
- 07 DETUNED HARMONIC CIRCUIT FILTER REACTOR
- 09 LINE REACTOR
- 11 V-SERIES AUTOMATIC VOLTAGE STABILIZER
- 15 S-SERIES AUTOMATIC VOLTAGE STABILIZER

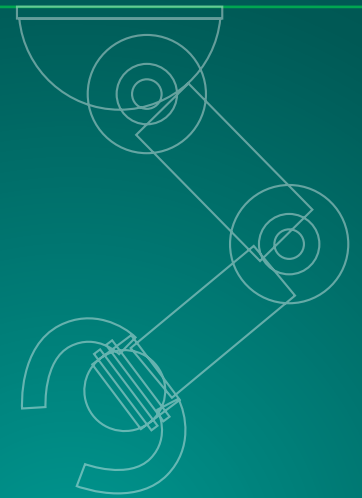

**technical data**

standard compliance

- IEC 60076
- EN 61558

**certifications**

CE

primary / secondary voltage range

- up to 1000V

**capacity**

- single phase  
50VA ~ 100KVA
- three phase  
50VA ~ 2000KVA

**winding material**

- copper or aluminium
- polyester enamelled wire  
155°C (Class F) &  
180°C (Class H)
- fiberglass wire  
180°C (Class H)

**silicon steel**

- good quality, non grained oriented and low loss grained oriented silicon steel

**varnish**

- high grade high temperature polyester varnish

**insulation class**

- class F or H

**cooling**

- natural air cool

**ambient temperature**

- maximum 40°C

**metal enclosure protection class**

- standard: IP20  
(other protection class is available upon request)

**standard series**



**three phase**



**single phase**



**metal enclosure**

**introduction**

QPS power transformer is suitable for any industrial, commercial, manufacturing and production process application. Power transformer can be offered for a variety of environment conditions, for instance K factor transformer, UPS transformer and marine transformer. QPS transformer is safe, reliable and durable. Not only do we produce top quality transformers but we also custom build transformers according to customers' design and specifications. With the continuous development in all phases of the design and manufacturing processes, we now offer dry-type transformers up to 3000KVA (3MVA).

**enclosures**

Enclosures for QPS transformers are manufactured from cold-rolled steel sheet and finished with epoxy powder coat. Different Ingress Protection (IP) categories could be supplied upon request, which is up to IP44. Enclosures can also be manufactured to meet customers' special requirements.

**type testing**

Upon request, the following type test can be carried out at extra costs.

- temperature rise test

Certifications by testing body are available upon request.

**accessories**

Optional accessories may be requested at an additional cost:

- over-current protection device: MCB / MCCB
- surge protection device
- temperature measurement device
- lamp indicator
- castor wheels
- ventilation fan

**facilities**

- foil winding machines
- wire winding machines
- vacuum impregnation facility
- comprehensive testing equipment



three phase



three phase



two phase

#### **k-factor transformer**

---

The use of electronic equipment is growing rapidly in both the commercial and industrial sectors. These electronic devices are powered by either switching power supplies or a rectifier circuit. Some examples of these devices include UPS, computers, fax machines and printers. These are contributing to the distortion of the current waveform and the generation of harmonics. Harmonics are defined as currents created by non-linear loads, which generate non-linear current waveforms. Some of the examples in which the harmonics presence include apparatus vibration, overheating of electrical equipment and electronic devices malfunction.

K-Factor transformer is designed to withstand the harmonic distortion associated with these loads. It is suitable for building security and as a bypass transformer for UPS systems, computers and peripherals, telecommunication, laboratory instrumentation and office automation.

#### **marine transformer**

---

QPS marine transformer is safe and durable, which is produced for ships or vessels. The transformer is manufactured in compliance with independent Marine Vessel requirements to maximize safety. The transformer is naturally air-cooled mounted in IP rated metal enclosures. FAT by independent body could be arranged upon customer's request, at an extra cost.

**capacity**

- single tapping @ 70%
- three tapping @ 50%, 60% and 75%

**E-I silicon steel grade**

- 0.5mm silicon steel

**cooling**

- natural air cool

**safety**

- thermostat protected for transformer above 11KW

**termination of wires**

- high quality nylon terminal block
- chrome steel metal bolts & nuts

**re-start frequencies**

- maximum re-start frequencies of 8 times per hour at appropriate intervals

**insulation class**

- class F

**optional**

- customize designs are available upon request

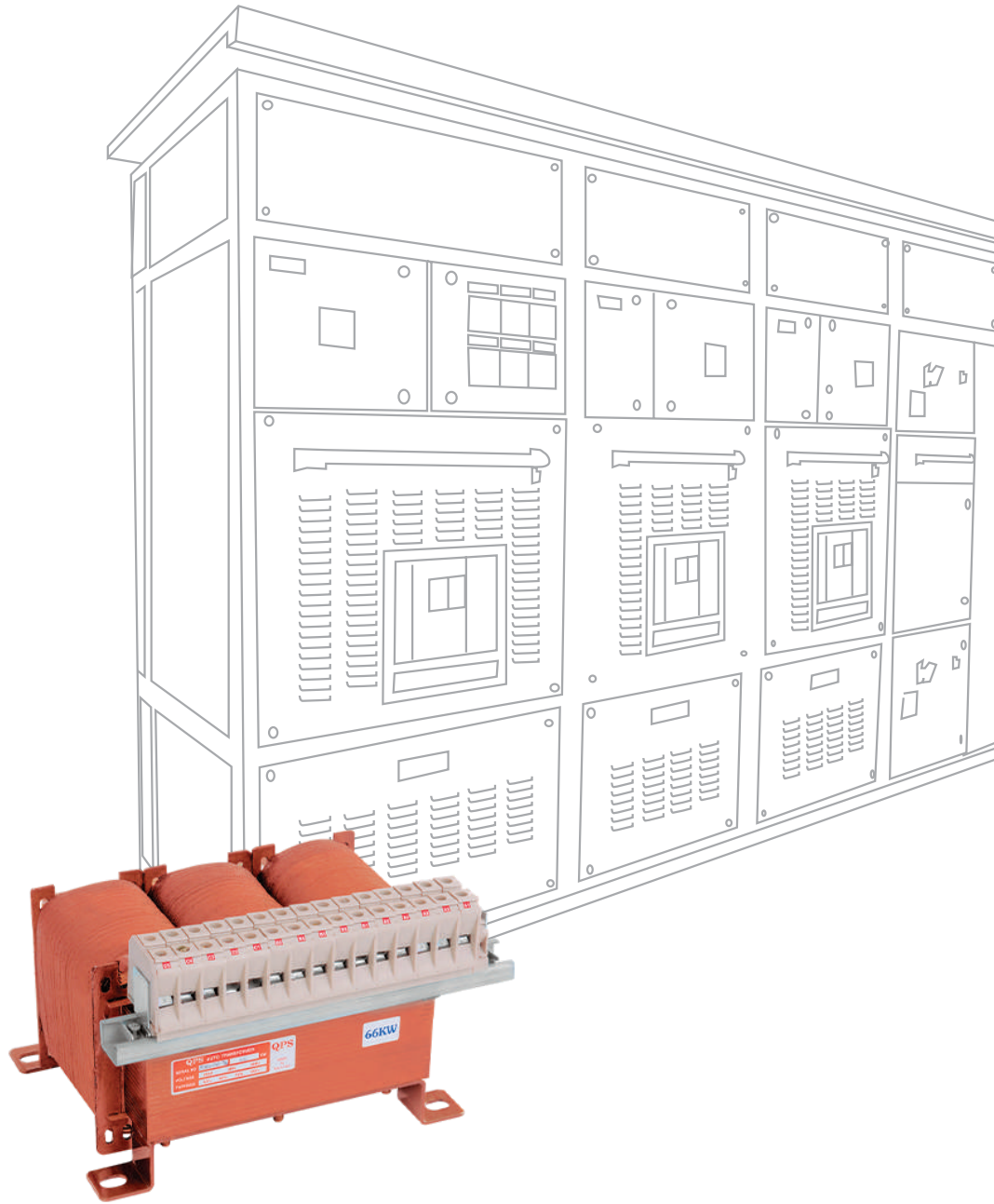

**dimension**

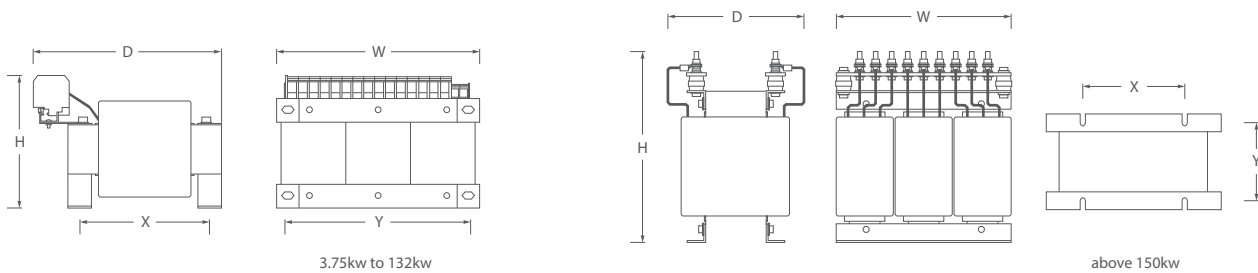

### technical specification for aluminium wire

capacity (kw)	hp	thermostat	no. of tapping	tapping percentage	mounting pitch (mm)		overall dimension (mm)			weight (kg)
					x	y	w	d	h	
3.75	5.0	nil/1	single	70%	120	185	215	195	90	5.5
5.5	7.5	nil/1	single	70%	120	185	215	195	95	6.5
7.5	10	nil/1	single	70%	120	185	215	195	100	7.0
11	15	nil/1	single	70%	140	210	240	215	100	9.5
11	15	1	three	50% 60% 75%	140	210	240	225	140	9.6
15	20	1	three	50% 60% 75%	140	210	240	225	155	11.5
22	30	1	three	50% 60% 75%	155	240	270	245	155	15.0
30	40	1	three	50% 60% 75%	155	240	270	245	160	16.5
37.5	50	1	three	50% 60% 75%	155	240	270	245	170	19.0
45	60	1	three	50% 60% 75%	185	270	300	275	170	20.5
56	75	1	three	50% 60% 75%	185	270	300	275	180	25.5
66	88	1	three	50% 60% 75%	185	270	300	275	210	34.0
80	107	1	three	50% 60% 75%	210	305	340	300	205	36.0
94	125	1	three	50% 60% 75%	210	305	340	300	215	41.0
110	150	1	three	50% 60% 75%	220	305	340	310	245	56.0
132	175	1	three	50% 60% 75%	220	305	340	310	255	61.0
150	200	3	three	50% 60% 75%	210	170	360	370	390	91.0
180	240	3	three	50% 60% 75%	260	170	410	380	400	105.0
225	300	3	three	50% 60% 75%	260	190	410	400	400	120.0

### technical specification for copper wire

capacity (kw)	hp	thermostat	no. of tapping	tapping percentage	mounting pitch (mm)		overall dimension (mm)			weight (kg)
					x	y	w	d	h	
3.75	5.0	nil/1	single	70%	120	185	215	195	90	6.1
5.5	7.5	nil/1	single	70%	120	185	215	195	95	7.5
7.5	10.0	nil/1	single	70%	120	185	215	195	100	8.6
11 (S)	15	nil/1	single	70%	140	210	240	215	100	10.7
11 3T	15	1	three	50% 60% 75%	140	210	240	225	145	12.4
15	20	1	three	50% 60% 75%	140	210	240	225	155	13.9
22	30	1	three	50% 60% 75%	155	240	270	245	150	17.3
30	40	1	three	50% 60% 75%	155	240	270	245	155	19.3
37.5	50	1	three	50% 60% 75%	155	240	270	245	155	21.1
45	60	1	three	50% 60% 75%	185	270	300	275	160	24.0
56	75	1	three	50% 60% 75%	185	270	300	275	180	30.3
66	88	1	three	50% 60% 75%	185	270	300	275	190	35.1
80	107	1	three	50% 60% 75%	210	305	340	300	210	42.3
94	125	1	three	50% 60% 75%	210	305	340	300	215	48.3
110	150	1	three	50% 60% 75%	220	305	340	310	235	62.5
132	175	1	three	50% 60% 75%	220	305	340	310	245	68.8
150	200	3	three	50% 60% 75%	210	170	360	370	390	100
180	240	3	three	50% 60% 75%	210	180	360	380	390	115
225	300	3	three	50% 60% 75%	210	190	360	390	390	130

**technical data**

- high efficiency of greater than 97%
- large cast aluminum carbon brush holder plate for better heat dissipation
- high-grade carbon brush with less than 0.5mm wear and tear after 100,000 cycles usage
- metal casing coated with epoxy paint to provide better surface protection
- enamel wire of PEW 150°C grade provides better working temperature
- improve starting current with the use of high quality grained oriented silicon steel core
- insulation and withstand voltage capable of reaching up to 20M ohm at 500VDC and 1.5kV respectively

**introduction**

Variable voltage transformers are very convenient and useful where different voltages are required to conduct tests or inspections. Examples are instrument calibration labs, QC department in the manufacturing sector, etc. They are also suitable for use as step-up or step-down transformers in areas where supply voltage is too low or too high.

We are the first local manufacturer of variable voltage transformers in Malaysia under the company's brand QPS. QPS has catered a range of single phase from 5 to 60 Ampere and three phase from 5 to 30 Ampere variable voltage transformers to suit different customers' needs.

QPS variable voltage transformer uses high quality materials and stringent quality controls to ensure that only high quality products are produced at all times. QPS variable voltage transformer provides more than just quality, reliability and compatibility. It also provides strong technical supports to our valuable customers.

**dimension**

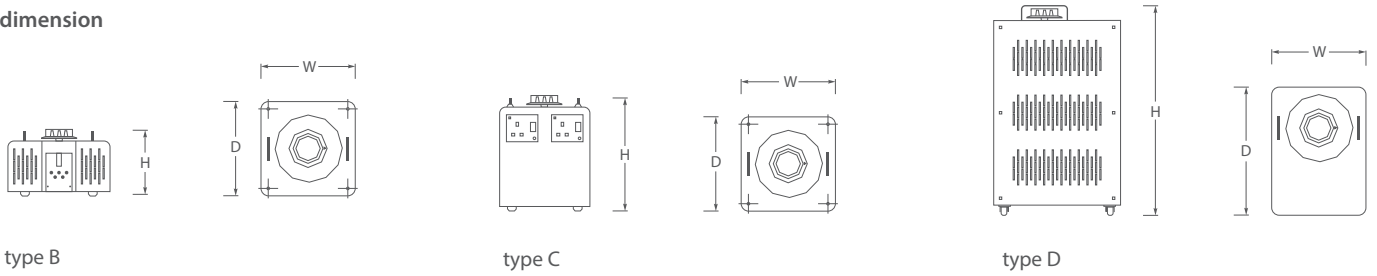

**technical specification**

model	type	maximum output current (A)	no. of phase	input voltage (V)	output voltage (V)	overall dimensions (mm)			weight (kg)
						w	d	h	
VT1-1	B	5	1	110 / 240	0 ~ 260	165	165	180	9
VT2-1	B	10	1	110 / 240	0 ~ 260	165	165	200	12
VT3-1	B	15	1	110 / 240	0 ~ 260	233	233	195	17
VT5-1	B	20	1	110 / 240	0 ~ 260	233	233	195	20
VT7-1	D	30	1	110 / 240	0 ~ 260	320	390	250	26
VT10-1	D	40	1	110 / 240	0 ~ 260	260	330	560	55
VT15-1	D	60	1	110 / 240	0 ~ 260	320	390	560	65
VT2-1-SC	C	10	1	240	0 ~ 260	225	213	270	14
VT3-1-SC	C	15	1	240	0 ~ 260	245	233	290	19
VT5-1-SC	C	20	1	240	0 ~ 260	245	233	290	22
VT3-3	D	5	3	415	0 ~ 450	220	280	530	28
VT6-3	D	10	3	415	0 ~ 450	240	310	560	45
VT9-3	D	15	3	415	0 ~ 450	260	330	560	58
VT15-3	D	20	3	415	0 ~ 450	260	330	560	65
VT20-3	D	30	3	415	0 ~ 450	320	390	560	80

Remarks: \*SC - complete with socket

**technical data**

**rated voltage**

· up to 440V

**filtering factor (uk)**

· 7%

**frequency of filter**

· 189Hz

**tolerance of inductance**

· +/- 5%

**linearity of inductance**

· 1.3In with +/- 5%

**test voltage**

· 3.0kV

**degree of protection**

· IP 00

**winding material**

- copper or aluminium
- polyester enamelled wire  
180°C (Class H)
- fibreglass wire 180°C  
(Class H)

**reactor core**

· 0.5mm high grade silicon steel  
from Japan & Korea

**varnish**

· high grade high temperature  
polyester varnish

**insulation class**

· class H

**ambient temperature**

· max 40°C

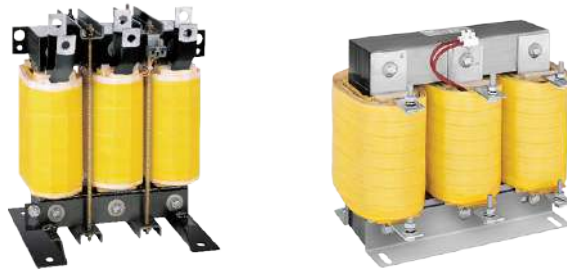

**diagram**

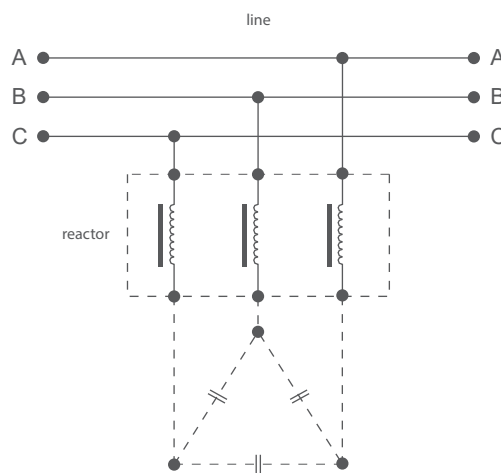

**introduction**

Power disturbance and harmonic distortion in electrical systems have proven to be fatal to equipment, cables, transformers, capacitor banks, etc. The situation has deteriorated further with the use of products such as variable speed drives, soft starters, rectifiers, UPS, discharge lamp, etc. These devices will generate or increase the harmonic distortion and high frequency interference in the power system. These disturbances will cause overheating to cables, transformer and related equipment, etc.

Detuned Harmonic Circuit Filter Reactor is used for:

- filtering harmonics and high frequency disturbance
- reduce high inrush current (from parallel switching of capacitors & from power to capacitor banks and thus improves the operating source life span of the capacitor)

Filtering % p is the ratio of inductance to capacitance. It is not to be confused with the impedance or reactance of an inductor.

For a 50Hz system:

- p=7% = 189Hz is used where protection to capacitor and harmonics reduction is required
- p=6% = 204Hz is to be used where the system is rich in 5th harmonics and above
- p=13% = 139Hz is used where voltage distortion exceed permissible limit

### Technical Data (p=7%)

1. The reactor is manufactured to withstand 125% capacitor current ( $I_1$ ) at its rated operating voltage.
2. Harmonic current handling capacity (for p=7.0% detuned reactor):
  - $I_1 = 1.06 I_c$  (fundamental current)
  - $I_3 = 0.04 \times I_1$  (3rd harmonic)
  - $I_5 = 0.31 \times I_1$  (5th harmonic)
  - $I_7 = 0.13 \times I_1$  (7th harmonic)
  - $I_{th} = 1.25 \times I_1$
3. Inductance tolerance is manufactured to be less than  $\pm 5\%$ .
4. Reactor Linearity still within 95~105% of their nominal inductance at 150% rated current. This assured maximum filtering of distortion even in the presence of severe harmonics and best absorption of surges.
5. Saturation of iron core: The reactor will not saturate (a drop of 10% of the nominal inductance at 175% of rated current).
6. Insulation-Class H 180°C. (Class F 155°C available upon request).
7. Operating Temperature: 120°C max. temperature rise at ambient temperature of 40°C.  
Thermostat 130°C (NC) is fitted to coil windings for over temperature protection.
8. Testing: insulation strength tested at 3kV @ 1 minute.
9. Noise level: below 55dB - reactor not hum at no harmonics condition.

### dimension

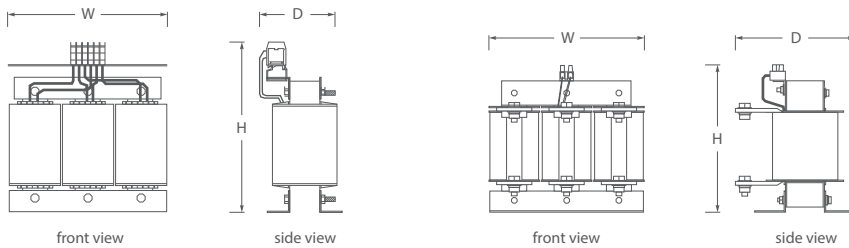

type A

type B

### detuned harmonic circuit filter reactor 525V 50Hz 7%

#### technical specification

model	type	525V capacitor rated power (KVAR)	rated current (A)	inductance (mH)	overall dimension (mm)			weight (kg)
					w	d	h	
A5K07525	A	5	5.1	12.281	165	120	140	3.7
A10K07525	A	10	10.1	6.141	180	115	185	7.0
A15K07525	A	15	15.1	4.094	180	125	185	8.6
A20K07525	A	20	20.1	3.070	180	135	185	8.7
A25K07525	B	25	25.1	2.456	250	135	195	11.6
A30K07525	B	30	30.2	2.047	250	140	195	12.7
A40K07525	B	40	40.2	1.535	250	150	195	14.1
A50K07525	B	50	50.3	1.228	265	160	195	16.7
A60K07525	B	60	60.4	1.023	270	205	230	22.8
A75K07525	B	75	75.4	0.819	320	200	280	30.5
A80K07525	B	80	80.4	0.768	320	200	280	30.5
A100K07525	B	100	100.6	0.614	320	215	280	33
A120K07525	B	120	120.6	0.512	320	235	280	35.8
A150K07525	B	150	151.1	0.409	375	270	280	50
A160K07525	B	160	160.9	0.384	375	270	280	52.4
A200K07525	B	200	201.1	0.307	410	270	320	58
A300K07525	B	300	301.9	0.205	435	295	320	76

**rated voltage**  
· 3 x 415V 50Hz

**% impedance**  
· 4%

**frequency**  
· 50Hz

**test voltage**  
· 2.5kV

**degree of protection**  
· IP 00

**rated current**  
· refer to table

**winding material**  
· copper or aluminium  
· polyester enamelled wire  
155°C (Class F) &  
180°C (Class H)  
· fiberglass wire  
180°C (Class H)

**reactor core**  
· 0.5mm high grade silicon steel  
from Japan and Korea

**varnish**  
· high grade high temperature  
polyester varnish

**insulation class**  
· class F or H

**ambient temperature**  
· max 40°C



**diagram**

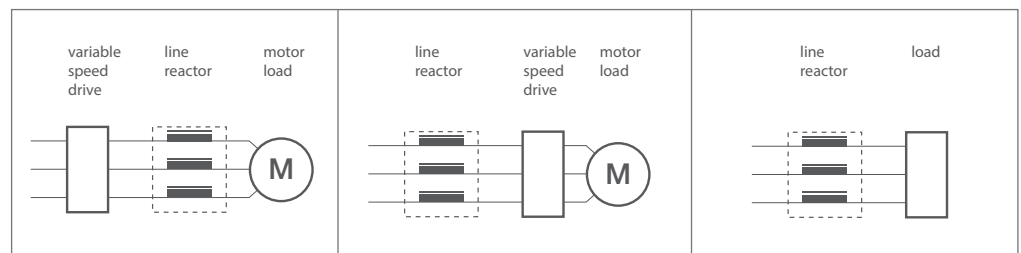

**line reactor:**  
· reduce inrush current  
· reduce noise and temperature of the motor  
· increase the life span of semiconductors

**line reactor:**  
· suppresses interference and transients generated from the electrical system  
· smooth the harmonics  
· reduce inrush current  
· increase the life span of semiconductors

**line reactor:**  
· suppresses interference coming from the electrical system or load  
· smooth the harmonics  
· reduce inrush current

**introduction**

With the increase in demand for better quality products at minimum cost, new equipment or machines are being developed using electronic devices to meet individual requirements. One of the devices that has gone through tremendous improvement is the variable speed drive. However, variable speed drives are very sensitive to line fluctuations and other nuisance problems.

Line reactors offer an economical solution to a variety of problems especially in variable speed drive installations. They act as current limiting device, as well as filters for electrical noises and harmonics generated from the loads. It is applicable to either the input or the output of the drives.

dimension

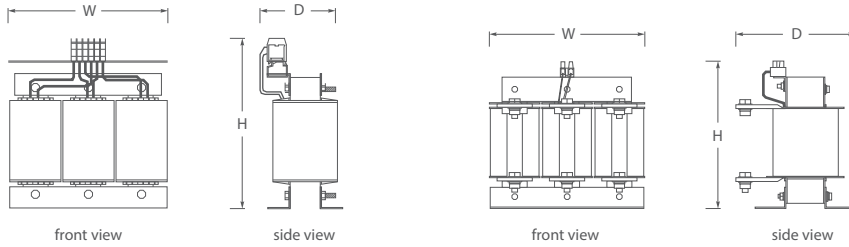

type A

type B

3 phase line reactor 415V 50Hz 4%

technical specification

model	type	current (A)	inductance (mH)	dimensions (mm)			weight (kg)
				w	d	h	
3LR8	A	8	3.813	175	130	170	3.9
3LR12	A	12	2.542	210	110	220	5.8
3LR18	A	18	1.695	210	125	220	7.5
3LR28	B	28	1.089	210	150	160	8.7
3LR40	B	40	0.763	210	165	160	10.9
3LR50	B	50	0.610	240	170	210	15.0
3LR63	B	63	0.484	240	180	210	17.4
3LR80	B	80	0.381	270	180	210	19.1
3LR125	B	125	0.244	270	205	210	26.6
3LR160	B	160	0.191	300	200	260	34.7
3LR200	B	200	0.153	315	220	260	38.0

**technical data**

**input voltage**

- single phase: 230V ±12%
- three phase: 415V ±12%
- + neutral

**output voltage (true rms)**

- single phase: 230VAC ±1.5%
- three phase: 415VAC ±1.5%

**rated kva**

- single phase: 1KVA ~ 30KVA
- three phase: 3KVA ~150KVA

**output waveform/  
distortion**

- sine wave/follow input

**response time**

- 0.05 ~ 0.07 sec/V

**frequency**

- 50 / 60Hz

**efficiency**

- > 95%

**over current protection**

- MCB / MCCB

**operating temperature**

- 0°C ~ 45°C

**SPD surge protection**

- 1 phase standard
- 3 phase (optional)

**phase loss sensing  
protection**

- phase sensing relay (optional)

**automatic output delay  
on system**

- time delay (optional)



**voltage fluctuation**

In the real world power line voltage occurs frequently especially in industrial area. Every electrical equipments and devices do have a working voltage limit/tolerance. Some equipment are build to tolerate ±10% of nominal voltage while others ±5% or less depending on sensitivity.

**effects**

The correct operation of electrical and electronic equipment depends on the voltage accuracy and stability. In the event of long time over voltage, it will lead to damage of the equipment; while long time under voltage will cause malfunction and computation errors of the electrical & electronic equipment.

**solutions**

Installing QPS Automatic Voltage Stabilizer (AVS) or power line conditioner will ensure the continuity and quality of production.

Input voltage variation from:

Single Phase: 230VAC ±12%

Three Phase: 415VAC ±12% + Neutral (3 phase 4 wire)

- excellent output voltage accuracy of within ±1.5% set value.

- regulation correction time approximately 0.05 ~ 0.07 sec per volt.

- minimum maintenance due to its simplicity in design.

- easy installation.

- tailor made to special voltages and configuration for example, three phase voltage without neutral or for outdoor configurations.

QPS Servo - Motor Automatic Voltage Stabilizer provides a continuous monitoring of the output voltage (true RMS sensing) by means of an electronic Control Circuit that compares the instantaneous output voltage with the set value. When changes are detected due to fluctuation of supply voltage or sudden changes in load, an electrical signal will be transmitted to the servo - motor which is coupled onto the brush gear of the variable transformer, causes the brush gear to rotate until the appropriate voltage is restored. This method of stabilization does not create interference or harmonic to the supply system. QPS Three phase Automatic Voltage Stabilizer also designed to cater for unbalanced load. This made possible with its independent phase monitoring system.

QPS Automatic Voltage Stabilizer offer high quality performance at competitive prices. They solve voltage unstable problems and increase productivity.

**power line conditioner**

QPS power line conditioner (PLC) is a AVS with the inclusion of a shielded isolation transformer.

**applications**

- CNC wire-cut / EDM
- CNC drilling machine
- CNC milling machine
- X – Ray equipment
- Industrial robots
- Communication system
- PLC equipment
- Broadcasting equipment
- Photographic processing equipment
- Photocopy machine
- Test equipment
- Computers
- Medical equipment
- LAB equipment

**standard features**

- over current circuit breaker
- analog voltmeter
- phase indicator lamps
- phase selector switch for voltmeter (for three phase only)

**optional features**

- surge protection device (SPD)
- phase loss (3 phase model) c/w programmable under / over voltage detector / phase sequence monitoring
- automatic output delay on system
- manual bypass switch

**single phase standard fittings**

single phase models  
 standard fittings come with phase pilot lamp, over current breaker and voltmeter with selector switch.

**input termination**

- power cord c/w 13A BS 3 pin plug – (model 1KVA, 2KVA & 3KVA)
- power cord c/w 15A BS 3 pin plug – (model 4KVA)
- terminal block for hardwire – (model 5KVA ~ 30KVA)

**output termination**

- 13A BS 3 pin socket – (model 1KVA ~ 15KVA)
- terminal block for hardwire – (model 3KVA ~ 30KVA)

**three phase standard fittings**

- over current breaker – (model 3KVA ~ 150KVA)
- voltmeter input – line / phase voltage – (model 30KVA ~ 150KVA)
- voltmeter output – (model 3KVA ~ 150KVA)

**phase pilot lamp, input and output termination**

- terminal block – (model 3KVA ~ 150KVA)

**diagram**

**Single Phase & Three Phase Servo – Motor Voltage Stabilizer Block Diagram**

**Legend**

- ST – series transformer
- VR – variable transformer
- ECC – electric control circuit
- M – servo-motor

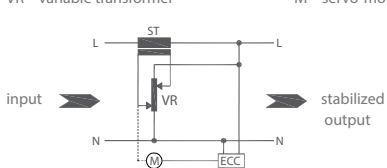

single phase avr / avr

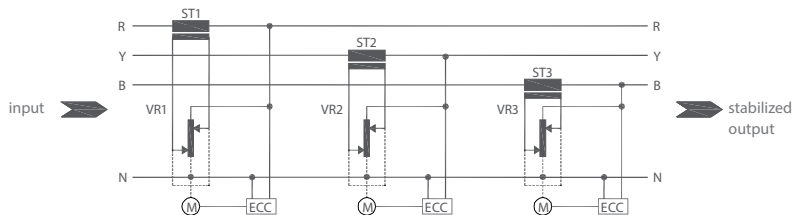

3-phase avr / avr independent phase control

dimension

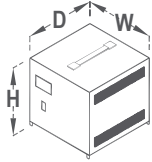

cabinet 1

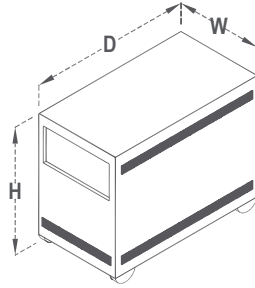

cabinet 2

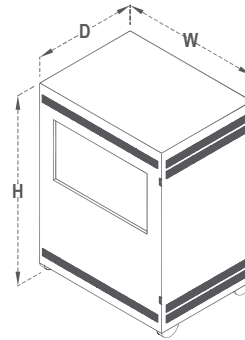

cabinet 3

single phase V-series 230VAC

technical specification

model	cabinet	power rated output (KVA)	rated / output current (A)	input voltage variation (%)	output accuracy	dimensions (mm) (+/-)			weight (kg) (+/-)
						h	w	d	
VSS1-2	1	1	4	230V ± 12%	±1.5%	183	200	220	8
VSS2-2	1	2	9	230V ± 12%	±1.5%	200	230	245	10
VSS3-2	1	3	13	230V ± 12%	±1.5%	283	260	330	23
VSS4-2	1	4	17	230V ± 12%	±1.5%	283	260	330	24
VSS5-2	1	5	22	230V ± 12%	±1.5%	283	260	330	24
VSS7-2	2	7.5	33	230V ± 12%	±1.5%	370	270	560	45
VSS10-2	2	10	43	230V ± 12%	±1.5%	370	270	560	50
VSS15-2	2	15	65	230V ± 12%	±1.5%	370	270	560	53
VSS20-2	3	20	87	230V ± 12%	±1.5%	640	400	375	57
VSS25-2	3	25	109	230V ± 12%	±1.5%	640	400	375	68
VSS30-2	3	30	130	230V ± 12%	±1.5%	640	400	375	73

Remarks: The dimensions indicated above is applicable for Automatic Voltage Stabilizer only. Please consult us if any further information is required.

dimension

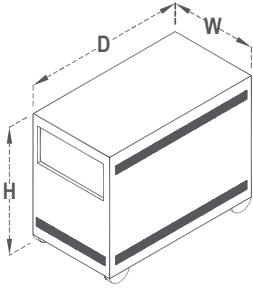

cabinet 1

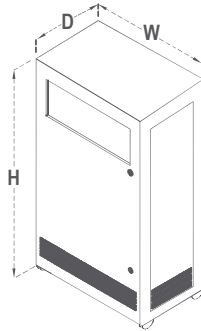

cabinet 2

**three phase V-series 415VAC**

**technical specification**

model	cabinet	power rated output (KVA)	rated / output current (A)	input voltage variation (%)	output accuracy	dimensions (mm) (+/-)			weight (kg) (+/-)
						h	w	d	
VST3-4	1	3	4	415V ± 12%	±1.5%	530	295	460	32
VST6-4	1	6	8	415V ± 12%	±1.5%	530	295	460	36
VST10-4	1	10	14	415V ± 12%	±1.5%	660	360	600	75
VST15-4	1	15	21	415V ± 12%	±1.5%	660	360	600	78
VST20-4	1	20	28	415V ± 12%	±1.5%	660	360	600	96
VST25-4	1	25	35	415V ± 12%	±1.5%	660	360	600	107
VST30-4	1	30	42	415V ± 12%	±1.5%	700	380	810	115
VST40-4	1	40	56	415V ± 12%	±1.5%	700	380	810	128
VST45-4	1	45	63	415V ± 12%	±1.5%	700	380	810	134
VST50-4	1	50	70	415V ± 12%	±1.5%	700	380	810	136
VST60-4	1	60	84	415V ± 12%	±1.5%	700	380	810	180
VST75-4	1	75	104	415V ± 12%	±1.5%	815	475	1070	213
VST100-4	1	100	139	415V ± 12%	±1.5%	815	475	1070	248
VST125-4	1	125	174	415V ± 12%	±1.5%	815	475	1070	270
VST150-4	2	150	209	415V ± 12%	±1.5%	1490	660	580	385

Remarks: The dimensions indicated above is applicable for Automatic Voltage Stabilizer only. Please consult us if any further information is required.

**technical data**

**input voltage**

- single phase: 230V ± 15%
- three phase: 415V ± 15%/10%  
+ neutral

**output voltage (true rms)**

- single phase: 230VAC ± 1.5%
- three phase: 415VAC ± 1.5%

**rated kva**

- single phase: 1KVA ~ 30KVA
- three phase: 3KVA ~ 1000KVA

**output waveform/**

**distortion**

- sinewave/follow input

**response time**

- 0.05 ~ 0.07 sec/V

**frequency**

- 50 / 60Hz

**efficiency**

- > 95%

**operating temperature**

- 0°C ~ 45°C

**over current protection**

- MCB / MCCB

**SPD surge protection**

- 1 phase standard
- 3 phase (optional)

**phase loss sensing**

**protection**

- phase sensing relay (optional)

**automatic output delay**

**on system**

- time delay (optional)



**voltage fluctuation**

In the real world power line voltage occurs frequently especially in industrial area. Every electrical equipments and devices do have a working voltage limit/tolerance. Some equipment are build to tolerate ±10% of nominal voltage while others ±5% or less depending on sensitivity.

**effects**

The correct operation of electrical and electronic equipment depends on the voltage accuracy and stability. In the event of long time over voltage, it will lead to damage of the equipment; while long time under voltage will cause malfunction and computation errors of the electrical & electronic equipment.

**solutions**

Installing QPS Automatic Voltage Stabilizer (AVS) or power line conditioner will ensure the continuity and quality of production.

Input voltage variation from:

Single Phase: 230V ± 15%

Three Phase: 415V ± 15% + Neutral (3 phase 4 wire)

- excellent output voltage accuracy of within ±1.5% set value.

- regulation correction time approximately 0.05 ~ 0.07 sec per volt.

- minimum maintenance due to its simplicity in design.

- easy installation.

- tailor made to special voltages and configuration for example, three phase voltage without neutral or for outdoor configurations.

QPS Servo - Motor Automatic Voltage Stabilizer provides a continuous monitoring of the output voltage (true RMS sensing) by means of an electronic Control Circuit that compares the instantaneous output voltage with the set value. When changes are detected due to fluctuation of supply voltage or sudden changes in load, an electrical signal will be transmitted to the servo - motor which is coupled onto the brush gear of the variable transformer, causes the brush gear to rotate until the appropriate voltage is restored. This method of stabilization does not create interference or harmonic to the supply system. QPS Three phase Automatic Voltage Stabilizers also designed to cater for unbalanced load. This made possible with its independent phase monitoring system.

QPS Automatic Voltage Stabilizers offer high quality performance at competitive prices. They solve voltage unstable problems and increase productivity.

**power line conditioner**

QPS power line conditioner (PLC) is a AVS with the inclusion of a shielded isolation transformer.

**applications**

- CNC wire-cut / EDM
- CNC drilling machine
- CNC milling machine
- X – Ray equipment
- Industrial robots
- Communication system
- PLC equipment
- Broadcasting equipment
- Photographic processing equipment
- Photocopy machine
- Test equipment
- Computers
- Medical equipment
- LAB equipment

**standard features**

- over current circuit breaker
- analog voltmeter
- phase indicator lamps
- phase selector switch for voltmeter

**optional features**

- surge protection device (SPD)
- over current protection (for model above 150KVA)
- phase loss / phase sequence monitoring (3 phase model)
- automatic output delay on system
- manual bypass switch

**single phase standard fittings**

single phase models  
 standard fittings come with phase pilot lamp, over current breaker and voltmeter with selector switch.

**input termination**

- power cord c/w 13A BS 3 pin plug – (model 1KVA , 2KVA & 3KVA)
- power cord c/w 15A BS 3 pin plug – (model 4KVA)
- terminal block for hardwire – (model 5KVA ~ 30KVA)

**output termination**

- 13A BS 3 pin socket – (model 1KVA ~ 5KVA)
- terminal block for hardwire – (model 5KVA ~ 30KVA)

**three phase standard fittings**

- over current breaker – (model 3KVA ~ 150KVA)
- phase selector switch for output voltmeter – (model 3KVA ~ 15KVA)
- phase selector switch for input & output voltmeter – (model 20KVA ~ 50KVA)
- phase selector switch for output voltmeter & ammeter – (model 60KVA ~ 200KVA)
- phase selector switch for input, output voltmeter & output ammeter – (model 250KVA ~ 1000KVA)
- phase indicator lamps (output)
- input & output terminal block (model 3KVA ~ 150KVA)

**diagram**

**Single Phase & Three Phase Servo – Motor Voltage Stabilizer Block Diagram**

**Legend**

- ST – series transformer
- VR – variable transformer
- ECC – electric control circuit
- M – servo-motor

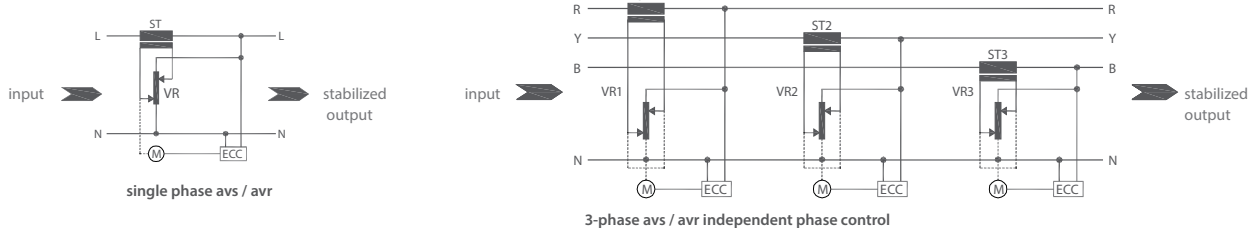

Note: All specifications are subject to change without prior notice for product improvement.

**dimension**

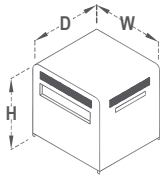

cabinet 1

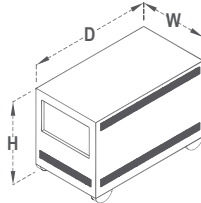

cabinet 2

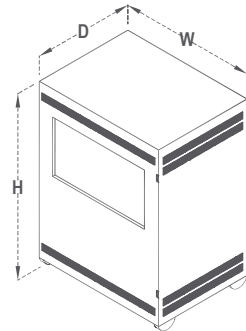

cabinet 3

**single phase S-series 230VAC**

**technical specification**

model	cabinet	power rated output (KVA)	rated / output current (A)	input voltage variation (%)	output accuracy	dimensions (mm) (+/-)			weight (kg) (+/-)
						h	w	d	
S1-2	1	1	4	230V ± 15%	± 1.5%	260	280	335	12
S2-2	1	2	9	230V ± 15%	± 1.5%	260	280	335	14
S3-2	1	3	13	230V ± 15%	± 1.5%	260	280	335	21
S4-2	1	4	17	230V ± 15%	± 1.5%	260	280	335	21.5
S5-2	2	5	22	230V ± 15%	± 1.5%	275	260	500	34
S7-2	2	7.5	33	230V ± 15%	± 1.5%	370	270	560	40
S10-2	2	10	43	230V ± 15%	± 1.5%	370	270	560	46.5
S15-2	2	15	65	230V ± 15%	± 1.5%	370	270	560	54
S20-2	3	20	87	230V ± 15%	± 1.5%	640	400	375	64
S25-2	3	25	109	230V ± 15%	± 1.5%	640	400	375	75
S30-2	3	30	130	230V ± 15%	± 1.5%	640	400	375	83

Remarks: The dimensions indicated above is applicable for Automatic Voltage Stabilizer only. Please consult us if any further information is required.



special casing



frame type



frame type

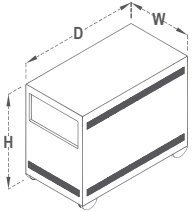

cabinet 1

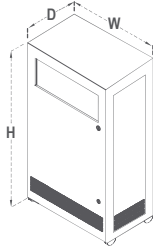

cabinet 2

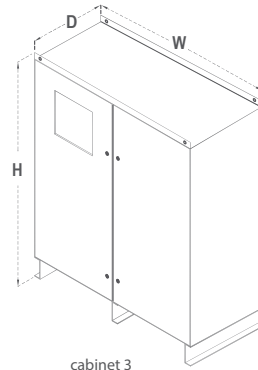

cabinet 3

**three phase S-series 415VAC**

**technical specification**

model	cabinet	power rated output (KVA)	rated / output current (A)	input voltage variation (%)	output accuracy	dimensions (mm) (+/-)			weight (kg) (+/-)
						h	w	d	
T3-4	1	3	4	415V±15%	± 1.5%	665	320	585	45
T6-4	1	6	8	415V±15%	± 1.5%	665	320	585	50
T10-4	1	10	14	415V±15%	± 1.5%	665	320	585	75
T15-4	1	15	21	415V±15%	± 1.5%	665	320	585	77
T20-4	2	20	28	415V±15%	± 1.5%	1110	570	500	159
T30-4	2	30	42	415V±15%	± 1.5%	1110	570	500	165
T40-4	2	40	56	415V±15%	± 1.5%	1110	570	500	180
T45-4	2	45	63	415V±15%	± 1.5%	1110	570	500	182
T50-4	2	50	70	415V±15%	± 1.5%	1110	570	500	190
T60-4	2	60	83	415V±15%	± 1.5%	1110	570	500	211
T75-4	2	75	104	415V±15%	± 1.5%	1110	570	500	225
T100-4	2	100	139	415V±15%	± 1.5%	1275	660	580	300
T125-4	2	125	174	415V±15%	± 1.5%	1275	660	580	345
T150-4	2	150	209	415V±15%	± 1.5%	1490	660	580	385
T200-4	2	200	278	415V±10%	± 1.5%	1490	660	580	380
T250-4	3	250	348	415V±10%	± 1.5%	1740	1400	800	550
T300-4	3	300	417	415V±10%	± 1.5%	1740	1400	800	732
T400-4	3	400	556	415V±10%	± 1.5%	1740	1400	800	986
T500-4	3	500	695	415V±10%	± 1.5%	1740	1400	800	1100
T600-4	3	600	835	415V±10%	± 1.5%	1955	1600	1400	1200
T700-4	3	700	974	415V±10%	± 1.5%	1955	1600	1400	1700
T1000-4	3	1000	1391	415V±10%	± 1.5%	1955	1600	1400	2000

Remarks: The dimensions indicated above is applicable for Automatic Voltage Stabilizer only. Please consult us if any further information is required.

Protection • Precision • Safety



## CONTENTS

- 20** CURRENT TRANSFORMER
- 22** RING TYPE - PVC TAPE SERIES
- 23** CASING TYPE - MBQ SERIES
- 24** CASING TYPE - MSQ SERIES

To protect large electrical system from overload or to monitor large current loads by means of a metering instrument **Current Transformer** plays a very important role. It provides the necessary tools to capture the actual load current and reduces its values by means of transformation ratio to a minimum of safe value. Therefore, selection of accurate and reliable current transformers are very crucial.

SES range of metering, measuring and protective current transformers are designed and manufactured to cater for wide range of applications. They are tested to **IEC61869-2 2012** and are certified to **ASTA & CE Mark Certified to UL**.

**Application guide to accuracy class**

Accuracy Class	Application
0.1	Precision Testing or as a standard for testing other CTs
0.2	Precision Metering
0.5	General Tariff Metering
1.0	Non Revenue measurement incl. power and energy
3.0	General industrial measurement
5.0	Approximate measurement

**Table - limit of current error and phase displacement for measuring current transformer (class 0.1 to 1)**

Accuracy Class	± Percentage current (ratio) error at percentage of rated current shown below					± Phase displacement at percentage of rated current shown below							
						Minutes				Centiradians			
	5	20	100	120	5	20	100	120	5	20	100	120	
0.1	0.4	0.2	0.1	0.1	15	8	5	5	0.45	0.24	0.15	0.15	
0.2	0.75	0.35	0.2	0.2	30	15	10	10	0.9	0.45	0.3	0.3	
0.5	1.5	0.75	0.5	0.5	90	45	30	30	2.7	1.35	0.9	0.9	
1.0	3.0	1.5	1.0	1.0	180	90	60	60	5.4	2.7	1.8	1.8	

**Table - limit of current error and phase displacement for special application**

Accuracy Class	± Percentage current (ratio) error at percentage of rated current shown below					± Phase displacement at percentage of rated current shown below									
						Minutes					Centiradians				
	1	5	20	100	120	1	5	20	100	120	1	5	20	100	120
0.2s	0.75	0.35	0.2	0.2	0.2	30	15	10	10	10	0.9	0.45	0.3	0.3	0.3
0.5s	1.5	0.75	0.5	0.5	0.5	90	45	30	30	30	2.7	1.35	0.9	0.9	0.9

**Table - limit of current error and phase displacement for measuring current transformer (class 3 to 5)**

Accuracy Class	± Percentage current (ratio) error at percentage of rated current shown below	
	50	120
3	3	3
5	5	5

Limits of phase displacement are not specified for class 3 and class 5.

Table - limit of current error for protection current transformer

Accuracy Class	Current error at Rated primary current %	Phase displacement at rated primary current		Composite error at rated accuracy limit primary current %
		Minutes	Centiradians	
5P	±1	±60	±1.8	5
10P	±3	–	–	10

### Specifications

Standard	IEC61869-2 2012
Rated operational voltage (Un)	720V
Rated frequency	50 / 60Hz
Ambient temperature	- 5 ~ 40°C
Operating humidity	up to 95% relative humidity
Rated short time thermal current (I <sub>th</sub> )	50kA
Rated dynamic current (I <sub>dyn</sub> )	125kA peak
Dielectric strength	3kV r.m.s for 1 minute
Thermal class of insulation	B
Tape	Non-adhesive PVC tape flame retardant
Casing	Non-flammable, polycarbonate self extinguishing ABS IPL
Accuracy class	Measuring 0.2, 0.5, 1, 3 Protection 5P, 10P, PX
Burden	1.5 to 15VA
Rated primary current	ranging up to 6000A
Rated secondary current	5A or 1A

### Burden Requirements

The Burden imposed on a Current Transformer consist mainly of the following:-

- The impedance of the relays or instruments.
- The impedance of pilot wire between current transformer and relay or instruments.
- The sum of (a) & (b) constitute the external burden required.

### Enquiry / Ordering Information

1. When enquiring or ordering, please specify the following:

- Ratio : 30 / 5A to 6000 / 5A  
20 / 1A to 6000 / 1A
- Class : 0.2, 0.5, 1, 3, 5.
- Burden (VA) : 2.5, 5, 10, 15, 20.
- ALF for Protective C/T : P5, P10, P15, P20.

2. For non-standard sizes, please provide additional informations such as:-

- Internal Diameter required in mm (D)
- Outer Diameter required in mm (OD)
- Height required in mm (HT)
- Rated secondary current if other than 5A

### Safety Precautions!

**The secondary terminals when not in used must be shorted before the primary supply is energised. Otherwise high voltage will develop across the secondary terminals causing damage to the current transformer and danger to life.**

Type	Measuring Current Transformer									Protection Current Transformer								
	Class 3 5VA			Class 1 15VA			Class 0.5 15VA			Class 10P5 15VA			Class 10P10 15VA			Class 5P10 15VA		
Ratio	ID	OD	HT	ID	OD	HT	ID	OD	HT	ID	OD	HT	ID	OD	HT	ID	OD	HT
60/5	28	70	28	28	70	102	-	-	-	34	100	148	25	145	155	25	145	165
100/5	34	74	23	34	80	70	34	80	185	34	100	98	34	100	168	34	100	180
150/5	34	74	23	34	80	48	34	100	72	34	100	68	34	100	108	34	100	130
200/5	45	80	28	34	80	33	34	80	92	34	100	55	34	100	88	34	100	110
250/5	45	80	28	45	80	38	45	80	70	45	96	60	45	96	108	45	96	110
300/5	45	80	28	45	80	38	45	80	60	45	96	55	45	96	100	45	96	110
400/5	60	96	23	60	96	23	60	96	40	60	100	55	60	100	100	45	96	90
500/5	65	100	23	68	100	23	65	100	30	60	100	45	60	100	85	60	100	100
600/5	65	100	23	68	100	23	65	100	30	65	100	45	68	110	70	68	110	80
800/5	85	122	23	85	122	28	85	122	40	85	122	40	85	122	65	85	122	80
1000/5	85	122	23	85	122	28	85	122	30	-	-	-	82	123	60	82	123	70
1200/5	90	130	28	90	135	28	90	135	33	-	-	-	90	135	60	90	135	70
1600/5	90	130	28	90	135	28	90	135	33	-	-	-	90	135	55	90	135	65
2000/5	122	165	25	122	165	25	122	165	30	-	-	-	120	178	40	120	178	40
2500/5	122	165	25	122	165	25	122	165	30	-	-	-	120	178	35	120	178	35
3000/5	120	165	25	120	165	25	120	165	30	-	-	-	118	178	35	118	178	35
4000/5	140	190	28	140	190	30	140	190	30	-	-	-	140	200	35	140	200	35
5000/5	140	190	28	140	190	30	140	190	30	-	-	-	140	200	35	140	200	35

All dimension in mm

Specifications are subject to change without prior notice.

Development is a continuous process and we reserve the right to supply products differing in construction or dimension from those illustrated and described.

Note: Others range of metering, measuring and protective current transformer are available upon request.

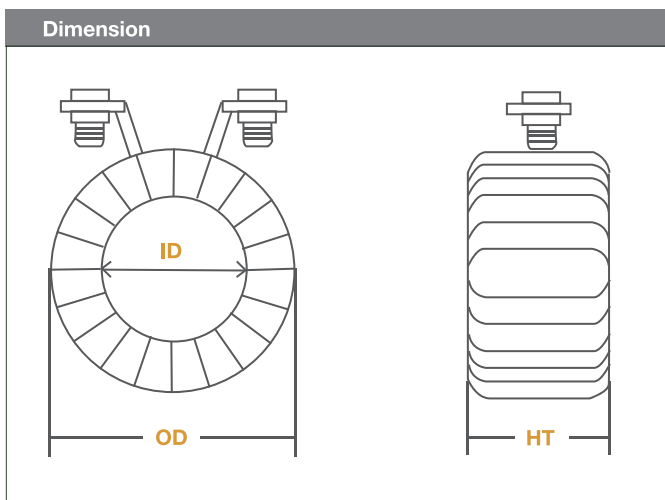

Type	MBQ 60/30		MBQ 60/40		MBQ 95/60		MBQ 95/70		MBQ 130/100	
Ratio	Burden (VA)		Burden (VA)		Burden (VA)		Burden (VA)		Burden (VA)	
	Class 1	Class 0.5	Class 1	Class 0.5	Class 1	Class 0.5	Class 1	Class 0.5	Class 1	Class 0.5
100/5	2.5	1.5	**	**	**	**	**	**	**	**
125/5	2.5	1.5	**	**	**	**	**	**	**	**
150/5	2.5	2.5	2.5	1.5	**	**	**	**	**	**
200/5	5	5	2.5	1.5	**	**	2.5	1.5	**	**
250/5	5	5	5	2.5	**	**	2.5	1.5	**	**
300/5	5	5	5	2.5	2.5	1.5	5	2.5	**	**
400/5	5	5	5	2.5	5	2.5	10	5	**	**
500/5	10	5	5	2.5	10	5	15	10	**	**
600/5	10	5	10	5	10	5	15	10	5	2.5
750/5	**	**	10	5	10	5	15	10	10	5
800/5	**	**	10	5	10	5	15	10	10	5
1000/5	**	**	**	**	15	10	15	15	15	10
1200/5	**	**	**	**	15	10	15	15	15	10
1250/5	**	**	**	**	15	10	15	15	15	10
1500/5	**	**	**	**	15	15	15	15	15	15
1600/5	**	**	**	**	15	15	15	15	15	15
2000/5	**	**	**	**	15	15	**	**	15	15
2500/5	**	**	**	**	**	**	**	**	15	15
3000/5	**	**	**	**	**	**	**	**	15	15

Specifications are subject to change without prior notice.

Development is a continuous process and we reserve the right to supply products differing in construction or dimension from those illustrated and described.

Note: Others range of metering, measuring and protective current transformer are available upon request.

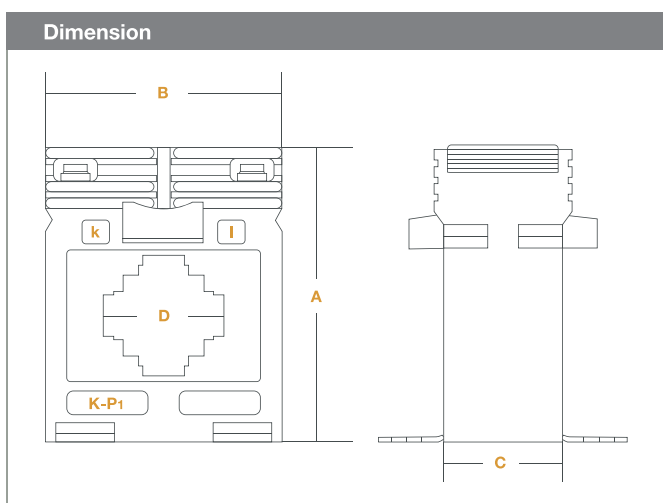

Type	A	B	C	D
MBQ 60/30	75	60	30	30 X 10
MBQ 60/40	75	60	30	40 X 10
MBQ 95/60	105	95	40	60 X 30
MBQ 95/70	105	95	40	60 X 10
MBQ 130/100	167	129	60	100 X 55

All dimension in mm



Type	MSQ 30		MSQ 40		MSQ 60		MSQ 85		MSQ 100		MSQ 125	
Ratio	Burden (VA)		Burden (VA)		Burden (VA)		Burden (VA)		Burden (VA)		Burden (VA)	
	Class 1	Class 0.5	Class 1	Class 0.5	Class 1	Class 0.5	Class 1	Class 0.5	Class 1	Class 0.5	Class 1	Class 0.5
100/5	5	2.5	1.5	1.5	**	**	**	**	**	**	**	**
125/5	5	2.5	1.5	1.5	**	**	**	**	**	**	**	**
150/5	5	5	2.5	1.5	**	**	**	**	**	**	**	**
200/5	10	5	5	2.5	**	**	**	**	**	**	**	**
250/5	10	10	5	2.5	2.5	1.5	**	**	**	**	**	**
300/5	10	10	5	2.5	5	2.5	**	**	**	**	**	**
400/5	15	15	10	5	10	5	7.5	5	**	**	**	**
500/5	15	15	10	5	10	5	7.5	5	**	**	**	**
600/5	15	15	15	10	10	5	10	5	7.5	5	**	**
750/5	**	**	15	10	10	5	10	5	7.5	5	**	**
800/5	**	**	15	10	15	10	10	5	10	5	**	**
1000/5	**	**	**	**	15	10	15	10	15	10	10	5
1200/5	**	**	**	**	15	15	15	10	15	10	15	10
1250/5	**	**	**	**	15	15	15	10	15	10	15	10
1500/5	**	**	**	**	15	15	15	15	15	15	15	15
1600/5	**	**	**	**	15	15	15	15	15	15	15	15
2000/5	**	**	**	**	**	**	15	15	15	15	15	15
2500/5	**	**	**	**	**	**	**	**	15	15	15	15
3000/5	**	**	**	**	**	**	**	**	15	15	15	15
4000/5	**	**	**	**	**	**	**	**	**	**	15	15
5000/5	**	**	**	**	**	**	**	**	**	**	15	15
6000/5	**	**	**	**	**	**	**	**	**	**	15	15

Specifications are subject to change without prior notice.

Development is a continuous process and we reserve the right to supply products differing in construction or dimension from those illustrated and described.

Note: Others range of metering, measuring and protective current transformer are available upon request.

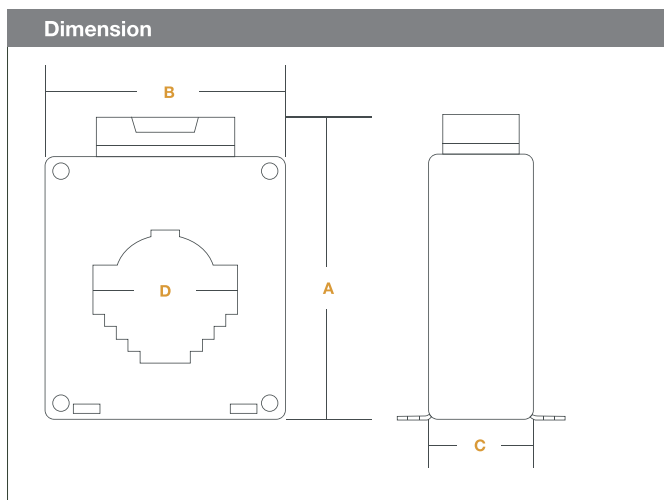

Type	A	B	C	D
MSQ 30	98	75	43	30 X 10
MSQ 40	98	75	43	40 X 10
MSQ 60	127	101	44	60 X 20
MSQ 85	164	128	42	80 X 30
MSQ 100	156	144	44	100 X 10
MSQ 125	220	190	42	125 X 58

All dimension in mm



Note: All specifications are subject to change without prior notice for product improvement.

# ***SUPER-LITE™***

## **CONTENTS**

---

- 2 Automotive Lead Acid Battery Charger Series**
- 6 Automotive Lead Acid Battery Charger Series - ECO**
- 8 Battery Charger / Engine Starter**
- 10 Constant Current Battery Charger**
- 12 Automatic Traction Battery Charger Series**
- 17 Golf Car Battery Charger Series**
- 18 Sealed Lead Acid Battery Charger Series**
- 19 Standby Automatic Battery Charger Series**
- 22 Battery Bank**
- 23 Battery Tester**

# Automotive Lead Acid Battery Charger Series

*SUPER-LITE™*



## introduction

*SUPER-LITE™* Lead Acid Battery Chargers are specifically designed for high volume battery charging, accommodating up to 9 pieces of 12V batteries or 18 pieces of 6V batteries connected in series. This capability is achieved through multiple voltage and current selections, allowing for various combinations of charging conditions to meet individual requirements. These chargers are housed in a heavy-gauge steel casing with an epoxy powder-coated finish and are available in two designs: one with fixed voltage/current and another with multiple voltage/current selections.

# Automotive Lead Acid Battery Charger Series

**SUPER-LITE™**



model	STM 1205	STM 1210	STM 1215	STM 2410
output	12Vdc	12Vdc	12Vdc	12Vdc ~ 24Vdc
max charging current	max 5Amp (low & high select)	max 10Amp (low & high select)	max 5Amp (low & high select)	max 10Amp (selectable)
safety protection	input fuse 2Amp, output auto fuse 7.5Amp	input fuse 2Amp, output auto fuse 15Amp	input fuse 3Amp, output MCB 20Amp	input fuse 3Amp, output MCB 16Amp
dimension (h x w x d)	(120 x 160 x 220) mm	(120 x 160 x 220) mm	(140 x 185 x 225) mm	(160 x 240 x 270) mm
weight	3.7kg	4.9kg	6.5kg	10.8kg

model: STM 1205 / STM 1210

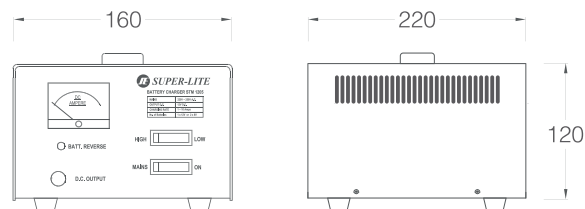

model: STM 1215

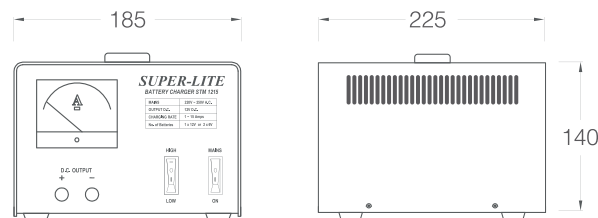

model: STM 2410

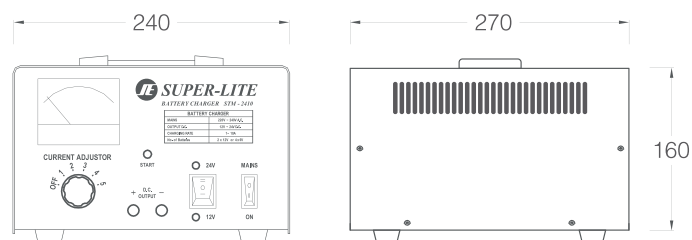

# Automotive Lead Acid Battery Charger Series

**SUPER-LITE™**



model	STM 2420	STM 4810	STM 4820
output	12Vdc ~ 24Vdc	6Vdc ~ 48Vdc	6Vdc ~ 48Vdc
max charging current	max 20Amp (selectable)	max 10Amp (selectable)	max 20Amp (selectable)
safety protection	input fuse 5Amp, output MCB 25Amp	input fuse 5Amp, output MCB 15Amp	input fuse 8Amp, output MCB 25Amp
dimension (h x w x d)	(300 x 340 x 330) mm	(300 x 340 x 330) mm	(300 x 340 x 330) mm
weight	21.8kg	18.8kg	25.5kg

model: STM 2420

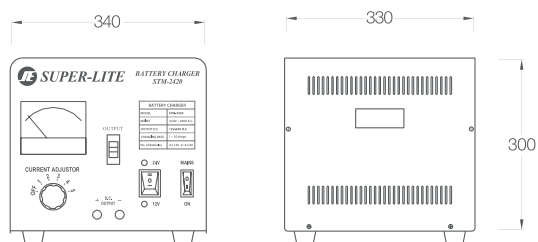

model: STM 4810 / STM 4820

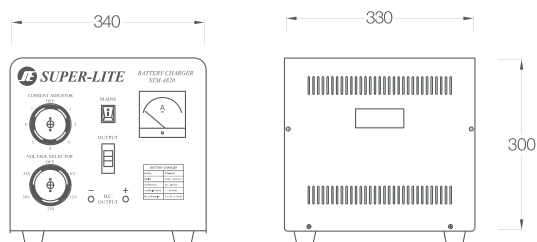

# Automotive Lead Acid Battery Charger Series

**SUPER-LITE™**



model	STM 9610 / STM 10810	STM 10815	SE 915
output	6Vdc ~ 96Vdc / 12Vdc ~ 108Vdc	12Vdc ~ 108Vdc	12Vdc ~ 84Vdc / 12Vdc ~ 108Vdc
max charging current	max 10Amp (selectable)	max 15Amp (selectable)	max 15Amp (selectable)
safety protection	input fuse 8Amp, output MCB 15Amp	input fuse 15Amp, input MCB 15Amp output MCB 25Amp	input fuse 15Amp, input MCB 15Amp
dimension (h x w x d)	(300 x 340 x 330) mm	(310 x 365 x 380) mm	(485 x 580 x 320) mm
weight	24.5kg / 26.5kg	40.0kg	48.0kg

model: STM 9610 / STM 10810

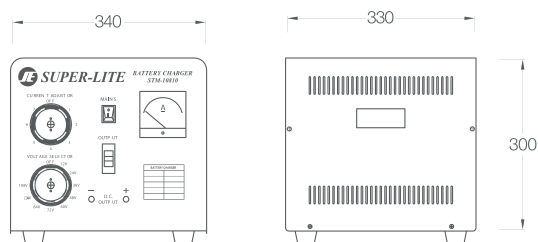

model: STM 10815

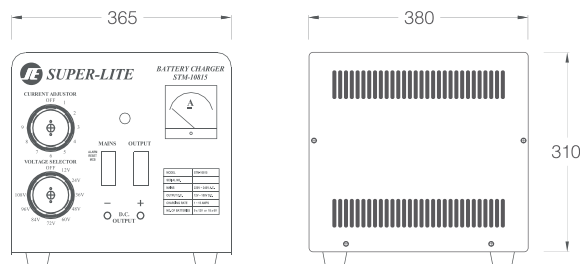

model: SE 915

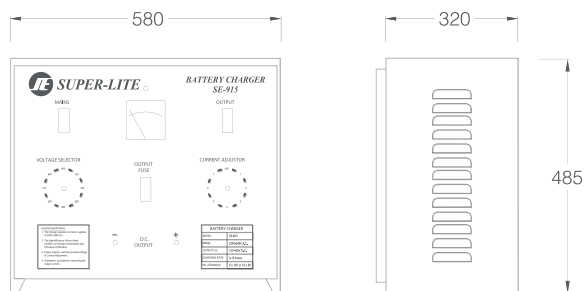

# Automotive Lead Acid Battery Charger Series



model	ECO 108	ECO 116
output	12Vdc	12Vdc
max charging current	max 8Amp (low & high select)	max 16Amp (low & high select)
safety protection	input fuse 2Amp, output auto fuse 7.5Amp	input fuse 2Amp, output auto fuse 15Amp
dimension (h x w x d)	(120 x 160 x 220) mm	(120 x 160 x 220) mm
weight	3.5kg	4.8kg

model: ECO 108

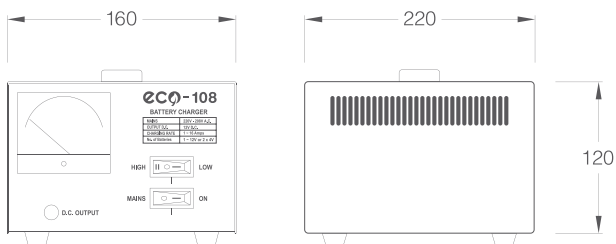

model: ECO 116

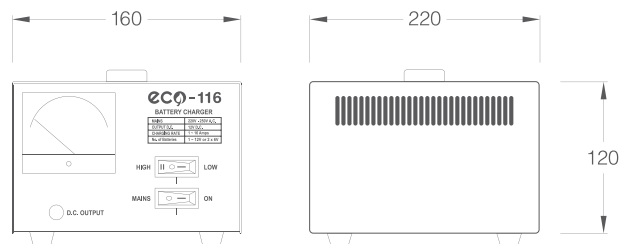

# Automotive Lead Acid Battery Charger Series



model	ECO 216	ECO 426
output	12Vdc	6Vdc ~ 48Vdc
max charging current	max 16Amp (selectable)	max 26Amp (selectable)
safety protection	input fuse 3Amp, output MCB 16Amp	input fuse 8Amp, output MCB 25Amp
dimension (h x w x d)	(160 x 240 x 270) mm	(300 x 340 x 330) mm
weight	9.7kg	22.5kg

model: ECO 216

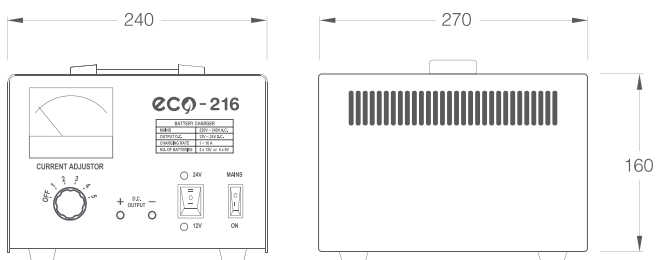

model: ECO 426

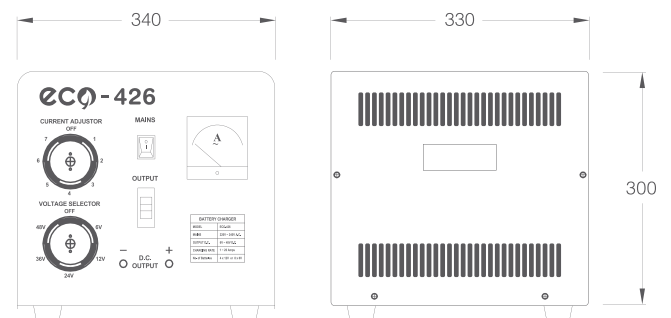



## introduction

**SUPER-LITE**™ Battery Charger/Engine Starter offers a range of features, including variable charge rates and a powerful boost function. It is designed for battery charging while keeping vehicles ready for operation.

- Operate as a slow charger, fast charger and booster
- Equipped with a timer for fast charging and automatic stop
- Selectable battery voltage control (12V & 24V)
- Input and output circuit breaker protection
- Adjustable charging current control
- Fitted with rubber wheels and a handle for easy mobility
- Built-in MCB for protection against overload and polarity inversion
- Durable design with minimal maintenance

# Battery Charger / Engine Starter

**SUPER-LITE™**



STM 2460



SMART 450

## technical specification

model: STM 2460

input voltage	220Vac - 240Vac 1 phase 50Hz
cranking power	350Amp
charging voltage	12Vdc - 24Vdc
charging current	1 - 60Amp (adjustable)
output	12V start - 4.2KW 24V start - 8.4W
weight	51.5kg

- a mobile starter/charger designed for garage and fleet use
- operator with a modern-style metal casing
- operate as a slow charger, fast charger and booster
- equipped with a timer for fast charging and auto stop function
- selectable battery voltage range control (12V & 24V)
- input and output circuit breaker protection
- variable and adjustable charging current control
- fitted with rubber wheels and a handle for easy mobility
- build-in MCB for overload and polarity protection

## dimensions

model: STM 2460

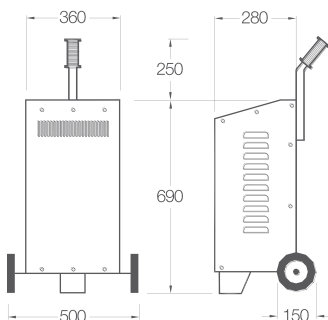

model: SMART 450

input voltage	220Vac - 240Vac 1 phase 50Hz
cranking power	450Amp
charging voltage	12Vdc - 24Vdc
charging current	1 - 60Amp (selectable)
output	12V start - 5.4KW 24V start - 10.8W
weight	38kg

- a mobile starter/charger designed for garage and fleet use
- operator with a modern-style metal casing
- operate as a slow charger, fast charger and booster
- selectable battery voltage range control (12V & 24V)
- input circuit breaker protection
- selectable charging current control
- fitted with rubber wheels and a handle for easy mobility

model: SMART 450

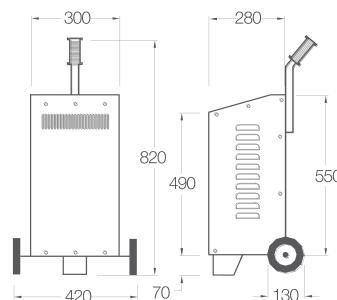



A fully automated *SUPER-LITE™* Constant Current Battery Charger designed for charging high volumes of unformed lead-acid batteries. The charging current can be easily adjusted to provide the most suitable charging conditions.

Due to its unique design, batteries with different voltages can be charged by connecting them in series, without exceeding the charger's rated maximum DC voltage. To increase the number of batteries per charge, parallel group of batteries are also supported. A built-in timer allows presetting of charging duration, with automatic shutdown once the set time is reached. It is suitable for manufacturing industries and workshops.

# Constant Current Battery Charger

**SUPER-LITE™**



STM 15015

## technical specification

model: STM 15015

input voltage	220Vac - 240Vac 1 phase 50Hz
output voltage	150Vdc
charging current	max 0 - 15Amp (adjustable)
safety protection	input MCB 20Amp output MCB 20Amp
time setting	0 - 99hrs
current & voltage display	analog DCA & DCV panel meters
enclosure finishing	epoxy powder coated
dimension (h x w x d)	(400 x 590 x 410) mm
weight	77.0kg

## dimensions

model: STM 15015

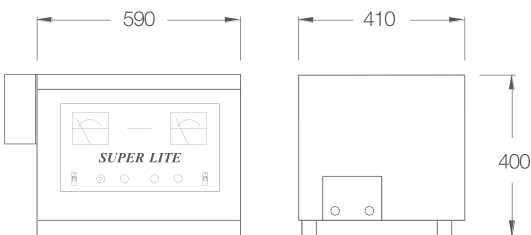

STM 15030

## technical specification

model: STM 15030

input voltage	220Vac - 240Vac 1 phase 50Hz
output voltage	150Vdc
charging current	max 0 - 30Amp (adjustable)
safety protection	input MCB 40Amp output MCB 40Amp
time setting	0 - 99hrs
current & voltage display	analog DCA & DCV panel meters
enclosure finishing	epoxy powder coated
dimension (h x w x d)	(500 x 760 x 510) mm
weight	134.0kg

model: STM 15030

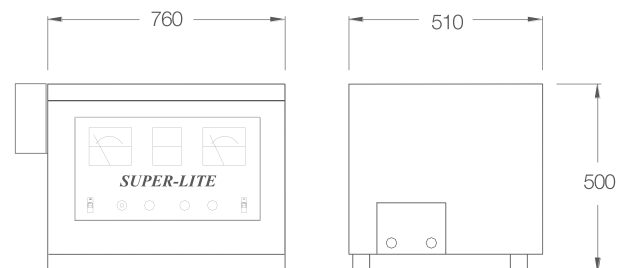

## Automatic Traction Battery Charger Series

***SUPER-LITE™***



***SUPER-LITE™*** Automatic Traction Battery Charger is specifically designed for charging electric truck batteries and compatible with various battery brands used in electric trucks. Battery condition and reliability are critical to ensure smooth operation of electric trucks. The advanced design of the Automatic Traction Battery Charger ensures batteries are fully recharged.

# Automatic Traction Battery Charger Series

**SUPER-LITE™**



S-Series

## technical specification

main supply	single-phase 240V
frequency	50/60Hz
DC output voltage	12V, 24V, 36V and 48V
DC output current	10A up to 60A
indicators	power on, 80% charged, 100% charged, equalisation and safety timer
protection	input MCB and output HRC fuse
overload protection	current limiting
operating temperature	0 to 40°C
enclosure finishing	mild steel coated with epoxy

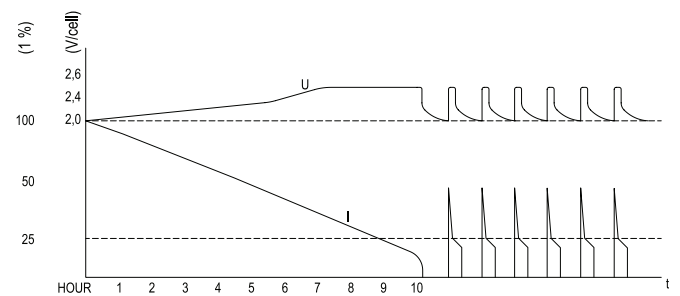

## features

- **u** - charging voltage curve
- **I** - charging current curve
- **t** - charging time

**SUPER-LITE™** Automatic Traction Battery Charger delivers a reliable performance to electric truck battery charging. It is fully automatic and available with a single-phase input.

## features

- fully automatic two-step charging
- Thyristor controlled rectification
- protected by a 13 hours safety timer
- WOWa charging mode
- equalisation cycle

# Automatic Traction Battery Charger Series

***SUPER-LITE™***

## S-Series

### technical specification

model	type	AC input	battery capacity	charging time
RC 1210-S	12V / 10A	1 Ø 240V @ 50Hz	50 ~ 65 Ah	9 - 12hrs
RC 1215-S	12V / 15A	1 Ø 240V @ 50Hz	65 ~ 95 Ah	9 - 12hrs
RC 1220-S	12V / 20A	1 Ø 240V @ 50Hz	95 ~ 125 Ah	9 - 12hrs
RC 1225-S	12V / 25A	1 Ø 240V @ 50Hz	125 ~ 155 Ah	9 - 12hrs
RC 1230-S	12V / 30A	1 Ø 240V @ 50Hz	155 ~ 190 Ah	9 - 12hrs
RC 1240-S	12V / 40A	1 Ø 240V @ 50Hz	190 ~ 250 Ah	9 - 12hrs
RC 1250-S	12V / 50A	1 Ø 240V @ 50Hz	250 ~ 315 Ah	9 - 12hrs
RC 1260-S	12V / 60A	1 Ø 240V @ 50Hz	315 ~ 375 Ah	9 - 12hrs
RC 2410-S	24V / 10A	1 Ø 240V @ 50Hz	50 ~ 65 Ah	9 - 12hrs
RC 2415-S	24V / 15A	1 Ø 240V @ 50Hz	65 ~ 95 Ah	9 - 12hrs
RC 2420-S	24V / 20A	1 Ø 240V @ 50Hz	95 ~ 125 Ah	9 - 12hrs
RC 2425-S	24V / 25A	1 Ø 240V @ 50Hz	125 ~ 155 Ah	9 - 12hrs
RC 2430-S	24V / 30A	1 Ø 240V @ 50Hz	155 ~ 190 Ah	9 - 12hrs
RC 2440-S	24V / 40A	1 Ø 240V @ 50Hz	190 ~ 250 Ah	9 - 12hrs
RC 2450-S	24V / 50A	1 Ø 240V @ 50Hz	250 ~ 315 Ah	9 - 12hrs
RC 2460-S	24V / 60A	1 Ø 240V @ 50Hz	315 ~ 375 Ah	9 - 12hrs
RC 3630-S	36V / 30A	1 Ø 240V @ 50Hz	155 ~ 190 Ah	9 - 12hrs
RC 3640-S	36V / 40A	1 Ø 240V @ 50Hz	190 ~ 250 Ah	9 - 12hrs
RC 3650-S	36V / 50A	1 Ø 240V @ 50Hz	250 ~ 315 Ah	9 - 12hrs
RC 3660-S	36V / 60A	1 Ø 240V @ 50Hz	315 ~ 375 Ah	9 - 12hrs
RC 4830-S	48V / 30A	1 Ø 240V @ 50Hz	155 ~ 190 Ah	9 - 12hrs
RC 4840-S	48V / 40A	1 Ø 240V @ 50Hz	190 ~ 250 Ah	9 - 12hrs
RC 4850-S	48V / 50A	1 Ø 240V @ 50Hz	250 ~ 315 Ah	9 - 12hrs
RC 4860-S	48V / 60A	1 Ø 240V @ 50Hz	315 ~ 375 Ah	9 - 12hrs

note: other capacity is available upon request.

# Automatic Traction Battery Charger Series

**SUPER-LITE™**



T-Series

## technical specification

main supply	three-phase 415V
frequency	50/60Hz
DC output voltage	12V, 24V, 36V, 48V, 72V and 80V
DC output current	30A up to 220A
indicators	power on, 80% charged, 100% charged, equalisation and safety timer
protection	input MCB and output HRC fuse
overload protection	current limiting
operating temperature	0 to 40°C
enclosure finishing	mild steel coated with epoxy

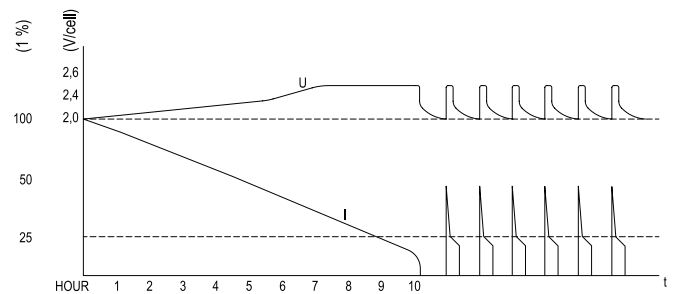

## features

- *u* - charging voltage curve
- *I* - charging current curve
- *t* - charging time

**SUPER-LITE™** Automatic Traction Battery Charger delivers reliable performance in electric truck battery charging, featuring a durable design. It is fully automatic and available with a single-phase input.

## features

- fully automatic two-step charging
- Thyristor controlled rectification
- protected by a 13 hours safety timer
- WOWa charging mode
- equalisation cycle

# Automatic Traction Battery Charger Series

***SUPER-LITE™***

## T-Series

### technical specification

model	type	AC input	battery capacity	charging time
RC 2440-T	24V / 40A	3 Ø 415V @ 50Hz	185 ~ 250 Ah	9 - 12hrs
RC 2460-T	24V / 60A	3 Ø 415V @ 50Hz	250 ~ 375 Ah	9 - 12hrs
RC 2480-T	24V / 80A	3 Ø 415V @ 50Hz	375 ~ 500 Ah	9 - 12hrs
RC 24100-T	24V / 100A	3 Ø 415V @ 50Hz	500 ~ 625 Ah	9 - 12hrs
RC 24120-T	24V / 120A	3 Ø 415V @ 50Hz	625 ~ 750 Ah	9 - 12hrs
RC 24140-T	24V / 140A	3 Ø 415V @ 50Hz	750 ~ 875 Ah	9 - 12hrs
RC 24160-T	24V / 160A	3 Ø 415V @ 50Hz	875 ~ 1000 Ah	9 - 12hrs
RC 24180-T	24V / 180A	3 Ø 415V @ 50Hz	1000 ~ 1125 Ah	9 - 12hrs
RC 3650-T	36V / 50A	3 Ø 415V @ 50Hz	180 ~ 250 Ah	9 - 12hrs
RC 3660-T	36V / 60A	3 Ø 415V @ 50Hz	250 ~ 375 Ah	9 - 12hrs
RC 3680-T	36V / 80A	3 Ø 415V @ 50Hz	375 ~ 500 Ah	9 - 12hrs
RC 36100-T	36V / 100A	3 Ø 415V @ 50Hz	500 ~ 625 Ah	9 - 12hrs
RC 36120-T	36V / 120A	3 Ø 415V @ 50Hz	625 ~ 750 Ah	9 - 12hrs
RC 36140-T	36V / 140A	3 Ø 415V @ 50Hz	750 ~ 875 Ah	9 - 12hrs
RC 36160-T	36V / 160A	3 Ø 415V @ 50Hz	875 ~ 1000 Ah	9 - 12hrs
RC 36180-T	36V / 180A	3 Ø 415V @ 50Hz	1000 ~ 1125 Ah	9 - 12hrs
RC 36200-T	36V / 200A	3 Ø 415V @ 50Hz	1125 ~ 1200 Ah	9 - 12hrs
RC 36220-T	36V / 220A	3 Ø 415V @ 50Hz	1200 ~ 1320 Ah	9 - 12hrs
RC 4840-T	48V / 40A	3 Ø 415V @ 50Hz	170 ~ 250 Ah	9 - 12hrs
RC 4860-T	48V / 60A	3 Ø 415V @ 50Hz	250 ~ 375 Ah	9 - 12hrs
RC 4880-T	48V / 80A	3 Ø 415V @ 50Hz	375 ~ 500 Ah	9 - 12hrs
RC 48100-T	48V / 100A	3 Ø 415V @ 50Hz	500 ~ 625 Ah	9 - 12hrs
RC 48120-T	48V / 120A	3 Ø 415V @ 50Hz	625 ~ 750 Ah	9 - 12hrs
RC 48140-T	48V / 140A	3 Ø 415V @ 50Hz	750 ~ 875 Ah	9 - 12hrs
RC 48160-T	48V / 160A	3 Ø 415V @ 50Hz	875 ~ 1000 Ah	9 - 12hrs
RC 48180-T	48V / 180A	3 Ø 415V @ 50Hz	1000 ~ 1125 Ah	9 - 12hrs
RC 48200-T	48V / 200A	3 Ø 415V @ 50Hz	1125 ~ 1200 Ah	9 - 12hrs
RC 48220-T	48V / 220A	3 Ø 415V @ 50Hz	1200 ~ 1320 Ah	9 - 12hrs
RC7260-T	72V / 60A	3 Ø 415V @ 50Hz	250 ~ 375 Ah	9 - 12hrs
RC7280-T	72V / 80A	3 Ø 415V @ 50Hz	375 ~ 500 Ah	9 - 12hrs
RC72100-T	72V / 100A	3 Ø 415V @ 50Hz	500 ~ 625 Ah	9 - 12hrs
RC72120-T	72V / 120A	3 Ø 415V @ 50Hz	625 ~ 750 Ah	9 - 12hrs
RC72140-T	72V / 140A	3 Ø 415V @ 50Hz	750 ~ 875 Ah	9 - 12hrs
RC72160-T	72V / 160A	3 Ø 415V @ 50Hz	875 ~ 1000 Ah	9 - 12hrs
RC72180-T	72V / 180A	3 Ø 415V @ 50Hz	1000 ~ 1125 Ah	9 - 12hrs
RC72200-T	72V / 200A	3 Ø 415V @ 50Hz	1125 ~ 1200 Ah	9 - 12hrs
RC8060-T	80V / 60A	3 Ø 415V @ 50Hz	250 ~ 375 Ah	9 - 12hrs
RC8080-T	80V / 80A	3 Ø 415V @ 50Hz	375 ~ 500 Ah	9 - 12hrs
RC80100-T	80V / 100A	3 Ø 415V @ 50Hz	500 ~ 625 Ah	9 - 12hrs
RC80120-T	80V / 120A	3 Ø 415V @ 50Hz	625 ~ 750 Ah	9 - 12hrs
RC80140-T	80V / 140A	3 Ø 415V @ 50Hz	750 ~ 875 Ah	9 - 12hrs
RC80160-T	80V / 160A	3 Ø 415V @ 50Hz	875 ~ 1000 Ah	9 - 12hrs

note: other capacity is available upon request.

# GC Series Golf Car Battery Charger

**SUPER-LITE™**

**SUPER-LITE™** The GC Series Golf Car Battery Charger is a portable lead-acid charger designed specifically for charging golf car deep-cycle batteries. This charger allows you to operate without worrying whether the battery is fully charged, thanks to the fully automated charging system incorporated within it. The input cable is fitted with a 3-pin 13A plug, which can be connected to any wall-mounted 13A socket and the output cable is fitted with a battery connector.

Electronic monitoring of the charging condition tracks the actual status during charging and is indicated by bright LEDs located on the front panel.



## features

rated supply voltage	240V 50Hz
battery type	lead acid battery
charging voltage	24Vdc, 36Vdc and 48Vdc
charging current	17A max
charging type	fully automatic charging
LED indicators	charger on, charging, 50% charged, 80% charged & fully charged
safety feature	MCB over current protection
cubical construction	aluminium casing

## technical specification

model	charging voltage (Vdc)	charging rate	dimension (mm) (h x w x d)
GC 2417	24V	17A	310 x 210 x 290
GC 3617	36V	17A	310 x 210 x 290
GC 4817	48V	17A	310 x 210 x 290

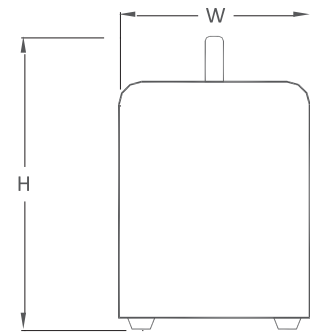

Front View

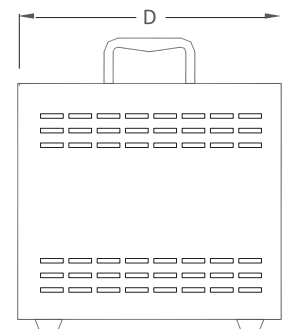

Side View

# Sealed Lead Acid Battery Charger Series

***SUPER-LITE™***



***SUPER-LITE™*** The SLA Series Battery Charger is a portable charger designed for charging sealed lead-acid batteries. It is incorporated with a fully automated charging system and the actual charging condition is indicated by an ammeter located on the front panel. The features are easy to operate.

## features

input rated voltage	220Vac ~ 240Vac 1Φ 50Hz
battery type	sealed lead acid battery / lead acid battery
charging voltage	12Vdc / 24Vdc
charging current	5A, 10A & 15A
charging type	fully automatic charging

## technical specification

model	SLA 1205	SLA 1210	SLA 1215	SLA 2405	SLA 2410	SLA 2415
battery voltage	12V	12V	12V	24V	24V	24V
charging rate	5A	10A	15A	5A	10A	15A

## Standby Automatic Battery Charger Series

*SUPER-LITE™*



The *SUPER-LITE™* Standby Automatic Battery Charger Series is used in switchboards for charging generator batteries. The battery condition is automatically maintained at full charge by the charger at all times, ensuring readiness for starting the generator when required. The Standby Automatic Battery Charger is also suitable for charging batteries used for standby applications only.

# SS & ES Series Standby Automatic Battery Charger

**SUPER-LITE™**

## features

- electronic current limiting
- incorporated with rectifier fail relay
- boost charging facility
- auxiliary trickle charging facility
- nickel cadmium / lead acid battery selection
- maximum charging current is limited to 5A, 10A, 15A and 20A respectively
- metal base plate fabricated from heavy gauge steel with epoxy finishing
- designed for vertical mounting to obtain good conventional cooling
- suitable for standby generator set battery charging



SS-Series



ES-Series

## technical specification

model SS-Series	supply voltage	output voltage	charging current (A)	fuse rating (A)	dimension (mm) (h x w x d)	weight (kg)
SABC-SS-1205	240Vac	DC 12V	5A	7.5A	115 x 245 x 310	4.3
SABC-SS-1210	240Vac	DC 12V	10A	15A	130 x 245 x 310	6.5
SABC-SS-1215	240Vac	DC 12V	15A	20A	165 x 245 x 360	8.9
SABC-SS-1220	240Vac	DC 12V	20A	32A	165 x 245 x 360	10.5
SABC-SS-2405	240Vac	DC 24V	5A	7.5A	115 x 245 x 310	5.5
SABC-SS-2410	240Vac	DC 24V	10A	15A	145 x 245 x 310	8.8
SABC-SS-2415	240Vac	DC 24V	15A	20A	185 x 245 x 360	12.0
SABC-SS-2420	240Vac	DC 24V	20A	32A	185 x 245 x 360	13.6

## rated supply voltage

- 240V +/- 10% 50Hz

## boost charge voltage for 12/24v batteries

- nickel cadmium battery  
- 15 – 15.5Vdc / 30 – 31Vdc
- lead acid battery  
- 14.5 – 15Vdc / 29 – 30Vdc

## float charge voltage for 12/24v batteries

- nickel cadmium battery  
- 14.25Vdc / 28.5Vdc
- lead acid battery  
- 13.75Vdc / 27.5Vdc

model ES-Series	supply voltage	output voltage	charging current (A)	fuse rating (A)	dimension (mm) (h x w x d)	weight (kg)
SABC-ES-1205	240Vac	DC 12V	5A	7.5A	135 x 210 x 210	3.6
SABC-ES-1210	240Vac	DC 12V	10A	15A	135 x 210 x 210	5.5
SABC-ES-2405	240Vac	DC 24V	5A	7.5A	135 x 210 x 210	4.9
SABC-ES-2410	240Vac	DC 24V	10A	15A	150 x 205 x 205	7.8

## circuit diagram (SS-Series / ES-Series)

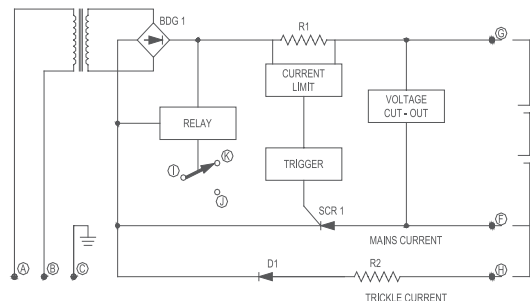

## dimension (ES-Series)

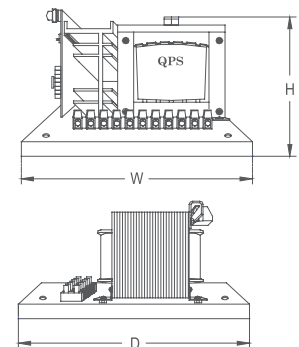

## dimension (SS-Series)

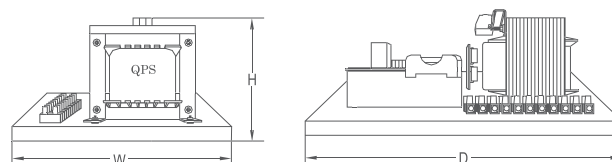

# CS & VS Series Standby Automatic Battery Charger

**SUPER-LITE™**

## features

- electronic current limiting
- incorporated with rectifier fail relay
- boost charging facility
- auxiliary trickle charging facility
- nickel cadmium / lead acid battery selection
- maximum charging current is limited to 5A and 10A respectively
- metal bracket fabricated from heavy gauge steel with epoxy finishing
- designed for vertical mounting to obtain good conventional cooling
- suitable for standby generator set battery charging



CS-Series



VS-Series

## technical specification

model CS-Series	supply voltage	output voltage	charging current (A)	fuse rating (A)	dimension (mm) (h x w x d)	weight (kg)
SABC-CS-1205	240Vac	DC 12V	5A	7.5A	170 x 140 x 135	5.3
SABC-CS-1210	240Vac	DC 12V	10A	15A	185 x 140 x 135	6.0
SABC-CS-2405	240Vac	DC 24V	5A	7.5A	185 x 140 x 135	5.7
SABC-CS-2410	240Vac	DC 24V	10A	15A	215 x 140 x 135	8.7

model VS-Series	supply voltage	output voltage	charging current (A)	fuse rating (A)	dimension (mm) (h x w x d)	weight (kg)
SABC-VS-1205	240Vac	DC 12V	5A	10A	138 x 98 x 103	3.0
SABC-VS-2405	240Vac	DC 24V	5A	10A	138 x 98 x 120	4.0

## rated supply voltage

- 240V +/- 10% 50Hz

## boost charge voltage for 12/24v batteries

- nickel cadmium battery - 15 – 15.5Vdc / 30 – 31Vdc
- lead acid battery - 14.5 – 15Vdc / 29 – 30Vdc

## float charge voltage for 12/24v batteries

- nickel cadmium battery - 14.25Vdc / 28.5Vdc
- lead acid battery - 13.75Vdc / 27.5Vdc

## circuit diagram

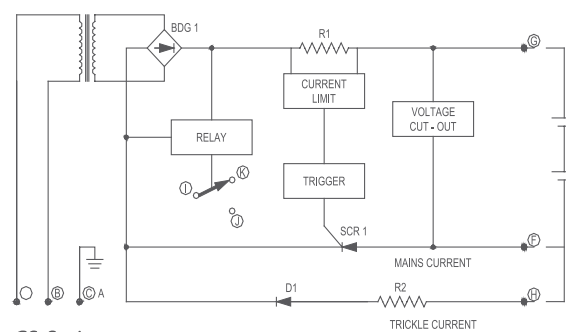

CS-Series

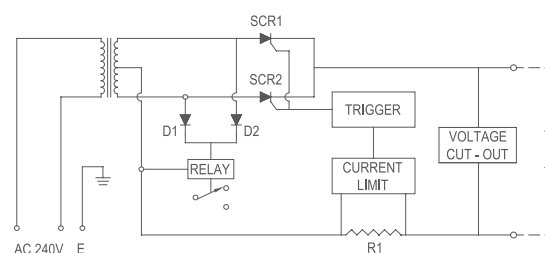

VS-Series

## dimension (CS-Series)

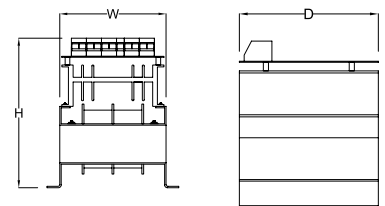

## dimension (VS-Series)

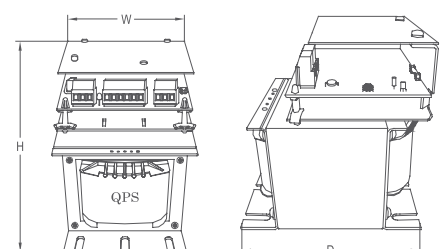

## features

- 12V battery for vehicles maintenance
- auto charger
- plug directly into a 12V car cigarette lighter socket
- robust metal enclosure

## design features

- easy to operate
- light and portable



In modern vehicles, a growing amount of data is stored within onboard electronic systems, maintained by the vehicle's 12V battery. Data is lost when the battery is disconnected. To prevent loss, a backup battery bank is required before disconnecting the battery. The *SUPER-LITE™* 12V DC Battery Bank is specifically designed to solve this problem.

## technical specification

model	12Vdc Battery Bank
supply voltage	240Vac
output voltage	12Vdc
frequency	50/60 Hz
safety features	fast blow glass fuse
enclosures finishing	epoxy powder coated
dimensions (h x w x d)	(175 x 110 x 250) mm
weight	5.0kg

## dimension

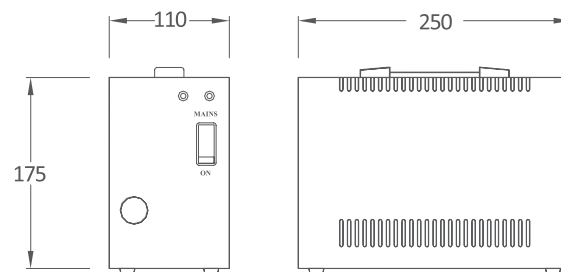

# Battery Tester

**SUPER-LITE™**



BT 101



BT 202



DC 12

The **SUPER-LITE™** 6V & 12V Battery Tester is designed for fast and accurate monitoring of battery condition. It is equipped with multiple test functions such as battery load testing, motor cranking testing and charging system testing.

A robust design, lightweight and a large display are some of its special features, providing users with flexibility of movement and quick judgement when carrying out tests. Heavy-duty insulated battery clamps are used to ensure safe and proper operation.

## features

battery rating	6V and 12V batteries
checking parameters	battery load test motor cranking test charging system test
safety features	reverse polarity protection automatic overload cut-off overload alarm (optional)
battery load test duration	10 seconds (maximum)
terminal clips	200Amps high quality clips

## technical specification

model	BT 101	DC-12	BT 202
battery capacity selection		√	√
temperature selection			√
automatic overload cut-off		√	√
battery rating (V)	6-12	12	12
motor cranking test	√	√	√
dimensions (h x w x d)	180 x 85 x 300	130 x 150 x 261	247 x 167 x 270
weight (kg)	2.0	3.5	4.0

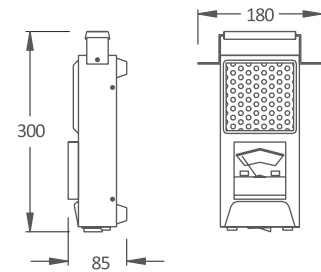

BT 101

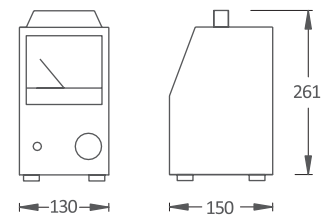

DC-12

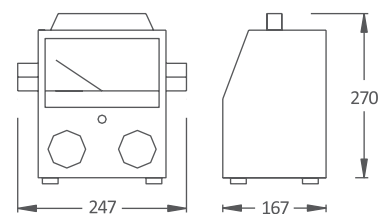

BT 202

# ACCREDITATIONS & CERTIFICATIONS

- UKAS accredited ISO 9001 Quality Management System (QMS)
- ASTA Certificate of Complete Type Tests for current transformers
- Compliance with Low Voltage Directive (LVD) certified by TÜV SÜD
- CE Mark for transformers
- MyHIJAU Mark (Malaysia's green recognition scheme)
- Forbes 'Best Under A Billion' 2008/2009

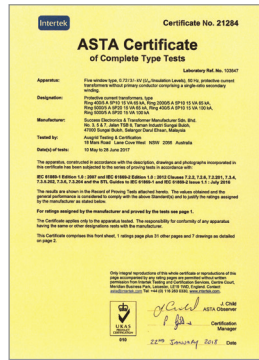

MyHIJAU Mark



Germanischer Lloyd



Nippon Kaiji Kyokai



Russian Maritime Register of Shipping



TÜV SÜD Mark



CE Mark



American Bureau of Shipping (ABS)



Det Norske Veritas (DNV)



Lloyd's Register Marine



[www.success.com.my](http://www.success.com.my)



**Success Electronics & Transformer  
Manufacturer Sdn. Bhd.**

199001009281 (200853-K)  
(A wholly owned subsidiary of Success  
Transformer Corporation Berhad)

No. 3, 5 & 7 Jln TSB 8, Taman Industri Sungai Buloh,  
47000 Sungai Buloh, Selangor Darul Ehsan, Malaysia.

**National Toll Free: 1300 88 2788**

**Tel : +603 - 6279 2800**

**Fax: +603 - 6157 2722**

**Sales Enquiry**

Domestic: [ses@success.com.my](mailto:ses@success.com.my)

Overseas : [export@success.com.my](mailto:export@success.com.my)